

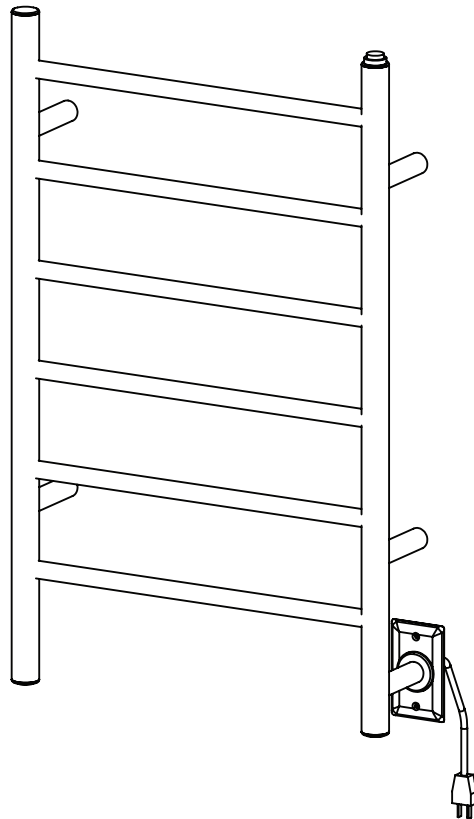

Comfort 6 Dual Towel Warmer



User Manual & Installation Instructions

IMPORTANT SAFETY INSTRUCTIONS
Carefully read the important information
regarding installation, safety and maintenance.
Keep these instructions for future reference.

MAAN5309-02
2020-07-02

Required Tools

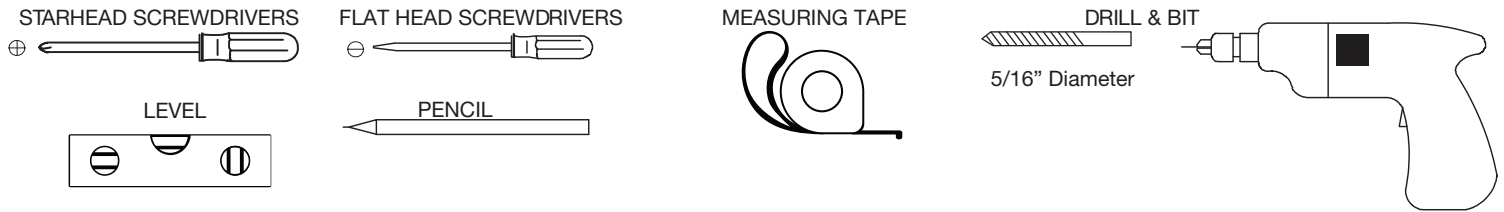

Electrical requirements: 120V, 80W, 60Hz, 0.67A. MUST HAVE A GROUND CONNECTION. Should be protected by a 15 amp GFI circuit breaker or equal.

READ ALL INSTRUCTIONS IN THE MANUAL BEFORE INSTALLING THIS TOWEL WARMER.

Before You Begin

Unpack the towel warmer carefully to avoid any damage or loss of any part. When opening the box, care should be taken to not discard packet of mounting screws. It is your responsibility to immediately inspect for any damage. Shipping damage should be reported immediately to your place of purchase.

Follow instructions to make sure your towel warmer is properly installed. **FAILURE TO FOLLOW THESE STEPS COULD RESULT IN HAZARDOUS CONDITIONS.**

To avoid possible fire hazard, the Towel Warmer must be mounted as intended. **MOUNT THIS UNIT AS SHOWN IN THESE INSTRUCTIONS.**

The towel warmer must be used in accordance with any prevailing code and relevant electrical wiring rules and regulations, in particular regulations that cover the use of products and accessories in damp situations such as showers, laundries and other areas with fixed water containers.

- Towel Warmer must be mounted vertical with cord in position as shown. No other position is safe or recommended.
- To provide continued protection against the risk of electrical shock, connect to properly grounded outlet only.
- Towel Warmer must be securely mounted to the wall. When possible, the Towel Warmer should be attached to adequate blocking or framing. Installations where blocking or framing is not available, must use appropriate wall anchors for mounting directly to sheetrock.



CAUTION:

1. Approved for domestic use only. Do not use outdoors.
2. Install in accordance with national and local codes.
3. Do not install in the shower, sauna or any wet locations.
4. Make sure towel warmer is properly secured to the wall before use.

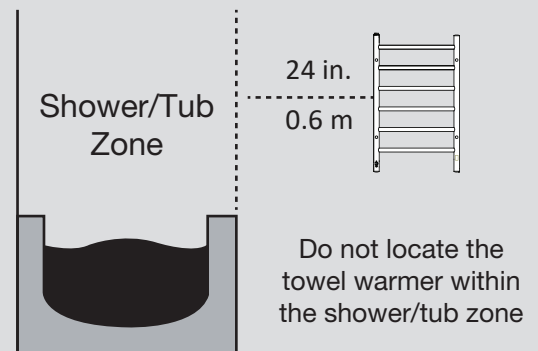

For illustrative purposes only







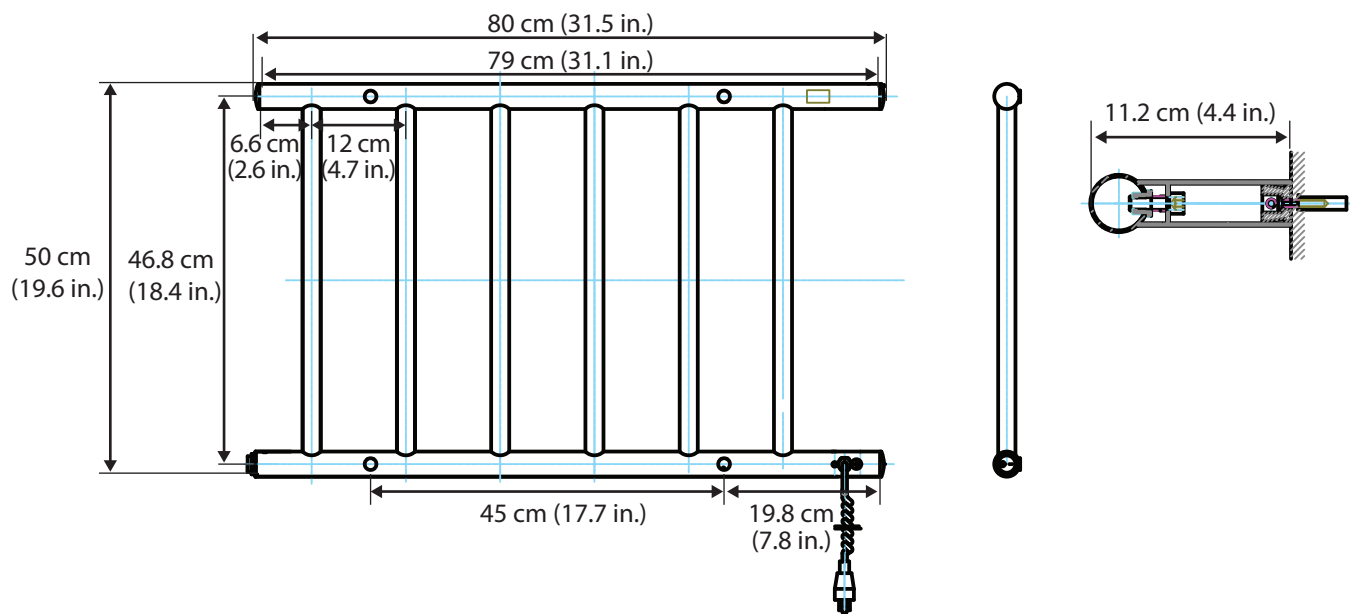



- Failure to follow the installation instructions may lead to overheating and malfunction.
- Any repairs that involve opening the Towel Warmer must be carried out by manufacturer or their representative.
- Please contact your supplier in the event of any problem or if repair is needed.

Product Dimensions



Parts for Plug-In Wall Mount Installation

- | | | |
|---|--|--|
| a  Metal wall leg
4 pieces | e  Set screw
4 + 1 pieces | j  Small Allen Key
1 piece |
| b  Large screw
4 + 1 pieces
M8*20 | f  Plastic plug
4 + 1 pieces | k  Large Allen Key
1 piece |
| c  Plastic insert
4 pieces | g  Screw
4 + 1 pieces | |

Plug-In Installation

1

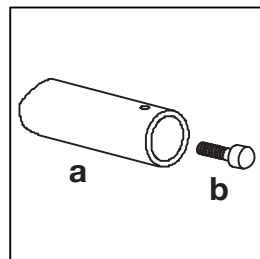
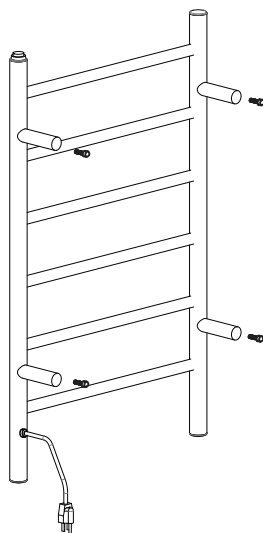

- Insert screw (b) to connecting tube (a).
- Use a screwdriver to attach screw (b) and tube (a) to the nut on the back of the frame.

2

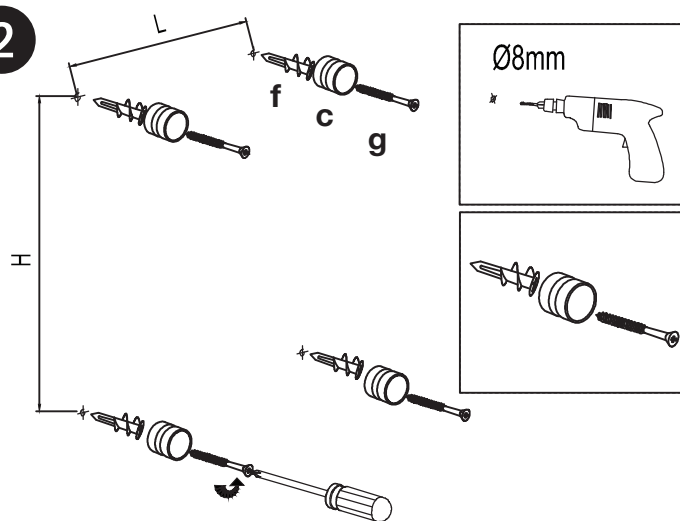

- Please check provided mounting screws and wall anchors are suitable for your home's construction.
- Drill the holes and insert the plastic screws (f) into the wall, then insert (c) and screw (g) to fix the support.

Plug-In Installation

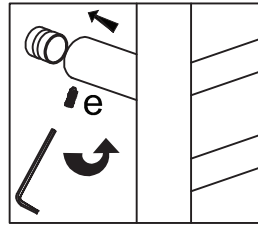
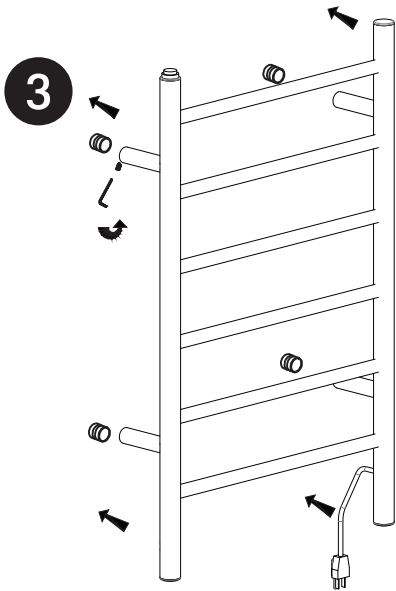

- Mount unit on support and tighten all the set screws (e) to the mounting tube (a) with Allen key.

4

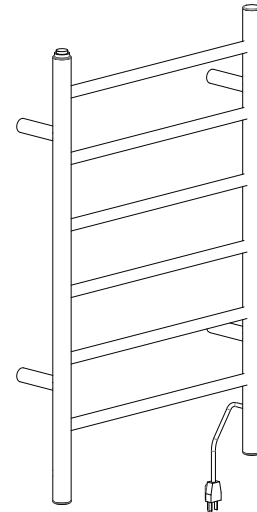

Parts for Hardwire Wall Mount Installation

a Metal wall leg
4 pieces

d Wall plate leg
1 piece

g Screw
4 + 1 pieces

j Small Allen key
1 piece

b Large screw
4 + 1 pieces
M8*20

e Set screw
4 + 1 pieces

h Plate
1 piece

k Large Allen key
1 piece

c Plastic insert
4 pieces

f Plastic plug
4 + 1 pieces

i Wall plate screws
2 + 1 pieces

Wall mount screw
1 + 1 pieces

Hardwire Installation

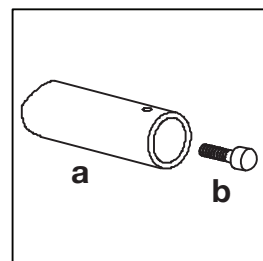
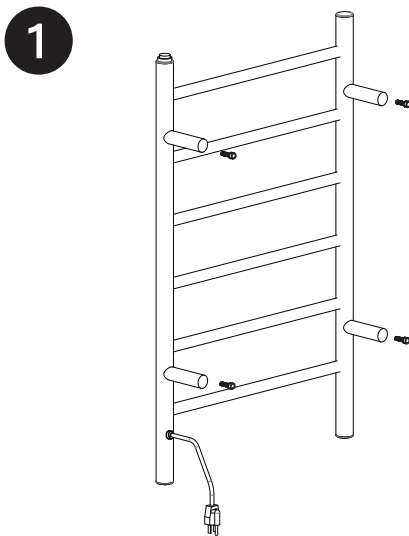

- Insert screw (b) to connecting tube (a).
- Use a screwdriver to attach screw (b) and tube (a) to the nut on the back of the frame.

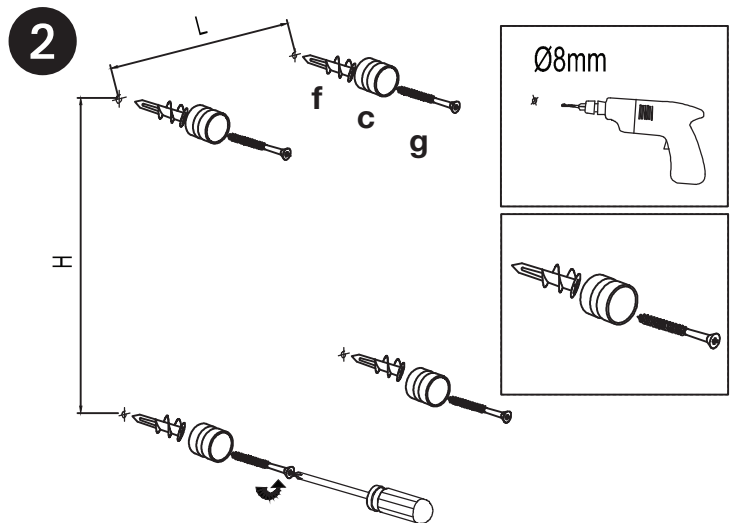

- Please check provided mounting screws and wall anchors are suitable for your home's construction.
- Drill the holes and insert the plastic screws (f) into the wall, then insert (c) and screw (g) to fix the support.

Hardwire Installation

3

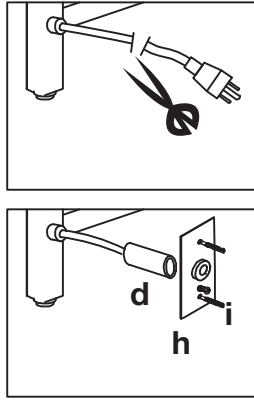
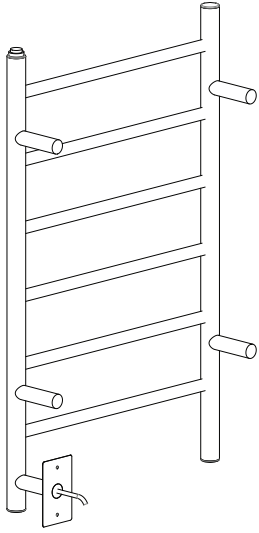

- Cut cable and leave its length at 25 cm (9.8 in.).
- Insert cable through tube (d) and plate (h).
- Insert screws (i) to plate (h).

4

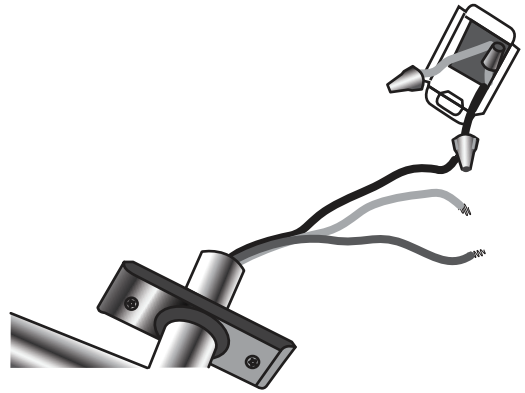

- Connect unit.
- All electrical connections in the junction box must be performed by a fully qualified electrician.**

5

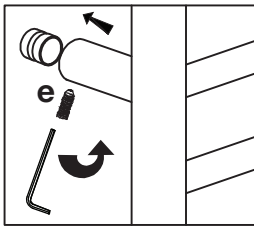
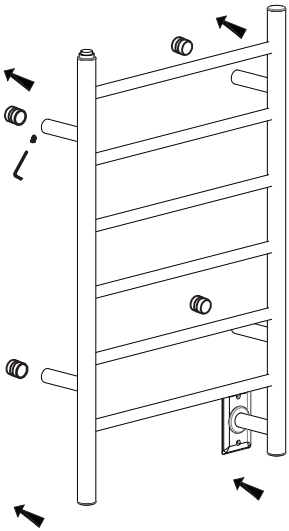

- Mount unit on support and tighten all the set screws (e) to the mounting tube (a) with Allen key.
- Fasten screws (i) to plate (h).

6

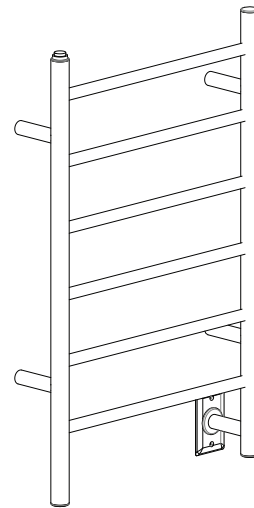

Operation and Maintenance Instructions

- After installation, connect the electric power and turn on the switch. The indicator light will show red and the towel warmer will start to work.
- Turn off the switch when the towel warmer is not in use. The indicator light will turn dark and the towel warmer will stop working.
- When cold, clean the towel warmer with a soft dry towel. Do not clean with abrasive cleaning powder.
- Unplug the unit if not in use for a long period of time.



CAUTION - Overlapping towels may increase towel warmer temperatures.

- **PROPERLY HANG TOWELS.**
- **DO NOT OVERLAP TOWELS.**

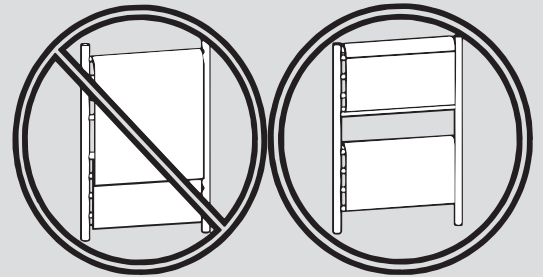

NOTE: There is no limit to how long a towel warmer can stay on. However, in order to conserve the life expectancy of our Ancona towel warmer, we recommend that the unit be on consecutively no more than two to three hours at a time.



- According to the National Electrical Code, all electrical work must be carried out by authorized licensed professionals. For your safety, please ensure you adhere to these regulations.
- Please ensure the power cord does not come in contact with the rail during operation.
- The power code is the means of disconnecting the unit from the main power outlet.
- The Towel Warmer will be hot. Please exercise caution if the Towel Warmer is accessible to children or the elderly. Please ensure that children are supervised at all times in the vicinity of the Towel Warmer and warn them that it is a hot surface that can cause burns.



HIGH OPERATING TEMPERATURE!

- Towel warmers are designed for heating towels and bathrobes and should not be used for other purposes. The manufacturer or reseller assumes no liability if the device is used in combination with equipment or accessories not sold by the manufacturer.
- This towel warmer is to be only used with fabrics that are water washable. Towels which contain soap or detergent residue may appear to have scorch marks; however, this is simply discoloration of the residue in the towels themselves. The unit does not reach a temperature sufficient to scorch towels.
- Never stand, sit or climb on the unit.
- This towel warmer operates at high temperatures that can cause burns. Do not touch surfaces of the towel warmer while the warmer is in operation. The unit is designed to warm up towel and may become very hot.
- Do not allow unsupervised children in the vicinity of the towel warmer; and warn children of hot surfaces. An adult must supervise when the device is used by or near children.
- Unplug the unit with a dry hand and ensure that the electrical circuit breaker is off the main panel before wiring, carrying out a repair or servicing your heated towel warmer.
- Do not place your towel warmer inside a shower, sauna or plunge into the water.
- To ensure continued protection against risk of electric shock, plug the unit into a properly grounded outlet.
- Approved for domestic use only. Do not use outdoors.

Information: service@anconahome.com or 1-800-350-4562

Please register your product warranty by visiting the Ancona Home website.



Canada & USA

Phone: 1-800-350-4562

Fax: 800-350-8563

Email: service@anconahome.com

Website: www.anconahome.com



MAAN5309-02

In-Wall 7 Day Digital Timer Instruction Sheet

1. Remove wall plate and disconnect existing light switch, install junction box with a qualified electrician.
2. Make sure both "hot" (black or red) and neutral (white) wires are present in the junction box. If both wires are not present, additional wiring will be necessary before installation can be completed.
3. Connect red timer wire to wire from towel warmer fixture, using wire connector. (1)
4. Connect black timer wire to the "hot" (usually black or red) wire in junction box using wire connector. (2)
5. Expose white wire in junction box (or open splice) and strip 1/2 in. of insulation to both wires.
6. Connect all three white wires together (timer wire, junction box wires) using wire connector. (3)
7. If the wall switch you are replacing had separate grounding conductors connected to the GREEN screw on the switch, make sure to connect these to the green wire from the timer with a wire connector. (4)
8. Check that all wire connections are secure.
9. Place all wires inside junction box.
10. Fit timer into junction box and install using two mounting screws (included).
11. Reconnect the electrical power

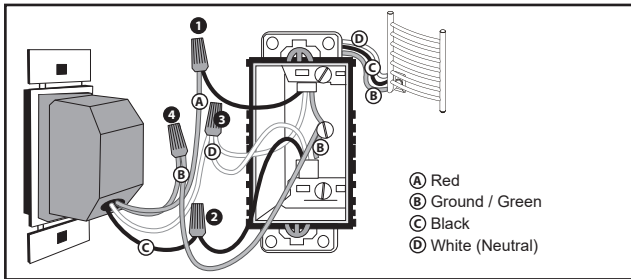

SETTING THE CLOCK

1. Press and hold the CLOCK button to set time.
2. Press the DAY button until the display shows the current day.
3. Press the HOUR button until the display shows the current hour.
4. Press the MIN (Minute) button until the display shows the current minute.

SETTING PROGRAMS

SET START TIME

1. a. Press the PROG (Program) button once. The display will look as shown at the right.
 
 b. You will now set up the time in which you want your device turned ON.
 c. The number 1 in the lower left hand corner indicates that you are now programming EVENT 1.

2. Press the DAY button repeatedly until the display shows the day(s) when you want the timer to turn on. The options are:

- All days of the week (MO, TU, WE, TH, FR, SA, SU)
- Individual days of the week (MO, TU, WE, TH, FR, SA, or SU)
- Weekdays only (MO, TU, WE, TH, FR)
- Weekends only (SA, SU)

3. Press the HOUR and MIN (Minute) buttons to set the time when you want the timer to turn on.

SET STOP TIME

4. Press the PROG (Program) button again. The display reads as shown at the right.
 
5. Repeat Steps 2 - 4 to set the OFF time for Event 1.
6. When programming is complete, press the CLK button to display the current time.

Things you should know about programming events

- You can repeat the ON and OFF programming procedures for up to 7 events.
- In order to use programmed times, **MODE must be set to AUTO or RDM**
- ON / OFF button **overrides** the current programmed events.

WARNING

While setting events, the timer may prematurely turn on the load, if you press the

MODE button. Three kinds of settings can cause the timer to work in an unexpected way:

- Do not set up events out of order. Be sure to set up events in progressive order of time (for example, 8:00pm ON, 9:00 pm ON, 10:00 pm ON — NOT 8:00 pm ON, 10:00 pm ON, 9:00 pm ON).
- Do not overlap event times (for example, 8:00 pm ON /12:00pm OFF, and 9:00 pm ON / 11:00 pm OFF).
- Do not set ON / OFF events within 30 minutes or less from one another if you are going to use the timer in the Random Mode.
The Random Mode interval is ± 15 minutes from the programmed times, and programs set too close together may overlap one another.

REVIEWING EVENTS PROGRAMMED

1. In the current time display, press the PROG (Program) button repeatedly to check your settings.
2. When finished, press the CLK button to return the display to the time of day.

CLEARING (DELETING) AN EVENT

1. Press the PROG (Program) button as many times as necessary to locate the setting you want to clear.
2. Press and hold the MODE button.
3. Press the PROG button to clear the setting.
4. When finished, press the CLK button to return the display to the time of day.

OPERATING THE TIME SWITCH

Press the MODE button repeatedly to set the timer to Automatic, Random or Manual mode.

NOTE: For the time switch to run programmed events, it must be set to "AUTO" mode.

AUTO: runs all events automatically, according to the schedule you have set. The word "AUTO" appears in the display.

RDM (Random): runs all events in a RANDOM mode. This is a security feature in which ON and OFF times randomly differ ± 15 minutes of the programmed times, creating a more "lived-in" look. The word "RDM" appears in the display.

NOTE: DO NOT set the ON / OFF events within 30 minutes or less from one another if you are going to use this timer in the RANDOM MODE. The RANDOM MODE is ± 15 minutes of programmed times and may overlap one another, causing the timer to possibly not work as desired.

MANUAL: turns ON and OFF only when the user presses the ON or OFF button. The display is blank, showing neither RDM or AUTO.

OVERRIDING TIMER SETTINGS

The ON / OFF button overrides the current programmed events. To override the current program (either ON or OFF), press the ON/OFF button.

NOTE: If the timer is not in "Manual" mode, it will obey the next programmed event. This allows the user to manually turn a light on and allow the program to shut the light back off at a preset time.

RESETTING THE TIMER

In case of an operational failure of the timer, insert a thin non-conducting object (like a wood toothpick) into the RESET orifice to clear all settings and restart.

If display screen is blank:

1. Connect timer to junction box.
2. Gently press the reset button until digital display appears.
3. Follow programming instructions.

*Works with CFL bulbs.

*This timer has been tested to work with standard compact fluorescent (CFL) bulbs. However, it will not control a CFL bulb that specifically states

NOTE: Timer installation is optional to towel warmer installation. Towel warmer fixtures DO NOT EXCEED RATED CAPACITY stated in this manual.

Rating:

General: 125 V ac, 60 Hz; 15 A, 1875W
 Resistive: 125 V ac, 60 Hz; 15 A, 1875W
 Tungsten (incandescent): 8 Amp, 125 VAC 1000 Watts
 Ballast (fluorescent): 8 Amp, 125 VAC
 Motor: 1/4 H.P., 125 VAC

IMPORTANT - Federal Communications Commission Interference Statement

This equipment has been tested and found to comply with the limits for Class B digital device, pursuant to part 15 of the FCC Rules. These limits are designed to provide reasonable protection against harmful interference in a residential installation. This equipment generates, uses and can radiate radio frequency energy and, if not installed and used in accordance with the instructions, may cause harmful interference to radio or television reception, which can be determined by turning the equipment off and on, the user is encouraged to try to correct the interference by one or more of the following measures:

- Reorient or relocate the receiving antenna.
- Increase the separation between the equipment and the receiver.
- Connect the equipment into an outlet on a circuit different from that to which the receiver is connected.
- Consult the dealer or an experienced radio/TV technician for help.

This device complies with Part 15 of the FCC Rules.

Operation is subject to the following two conditions:

- (1) This device may not cause harmful interference, and
- (2) this device must accept any interference received, including interference that may cause undesired operation of the device.

FCC Caution: Any changes or modifications not expressly approved by the party responsible for compliance could void the user's authority to operate this equipment.

Industry Canada statement:

This Class B digital apparatus complies with Canadian ICES-003.

This device complies with Industry Canada license-exempt RSS standard(s).

Operation is subject to the following two conditions:

- (1) this device may not cause interference, and
- (2) this device must accept any interference, including interference that may cause undesired operation of the device.