



# Industria

Single Hole Bathroom Faucet

### STANDARDS

- ASME A112.18.1-2012
  - CSA B125.1-12
  - NSF 61-9
  - LISTED IAPMO/cUPC
- 
- 1.2 gpm/4.5 L/min

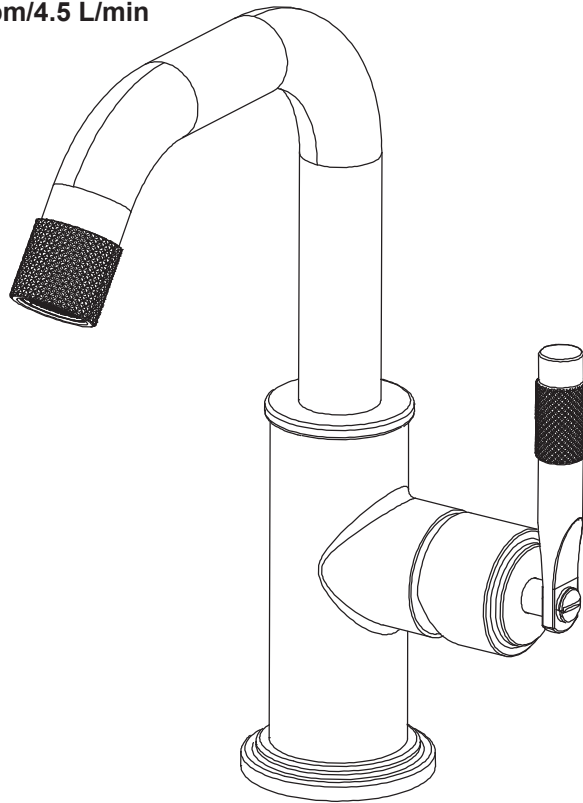

## Helpful Information

### Tools:

Gather the necessary tools as shown below to complete the installation of this faucet. Some may not be needed depending on the model of faucet you are installing. Check with your local hardware store on the requirements of your installation situation.

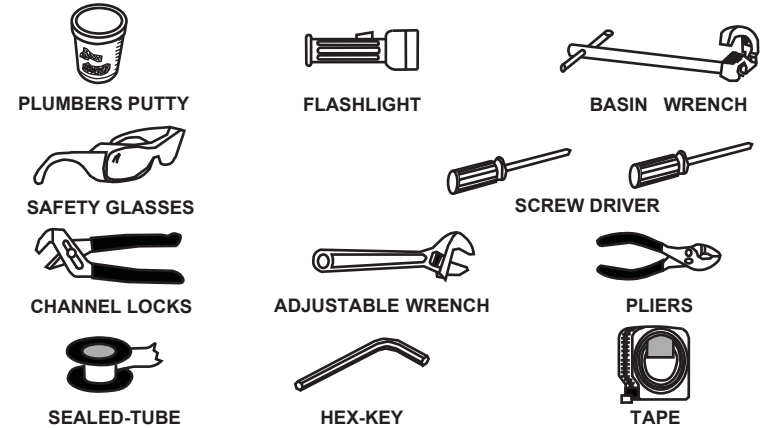

## Configuration

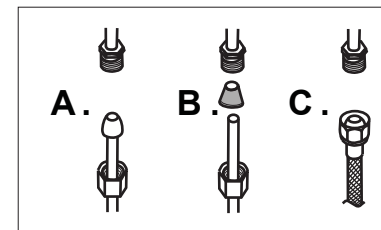

Connect to water supply lines with either:  
(A) 3/8" O.D.copper tubing (ball nose risers with the coupling nuts or;  
(B) 3/8" copper tubing (no ball)with supplied tube head interior connector or;  
(C) IPS faucet connectors (1/2" ) .

## Important

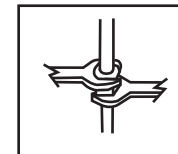

Tighten connection with two wrench to prevent damage to tube body. Be careful not to bend the stem as this will void the product warranty.

## Installation Size Map

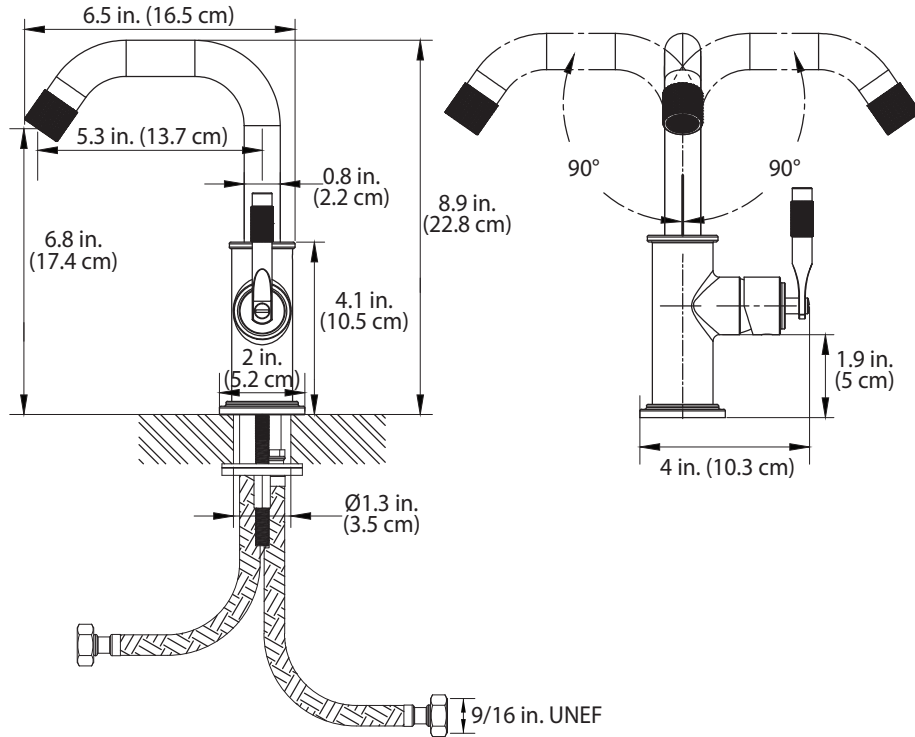

## Test Faucet Installation

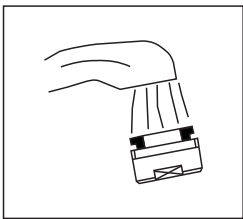

- A. Move handle into "OFF" position.
- B. Turn on water supplies. Check connections for leaks.
- C. Remove aerator and let both hot and cold water run for one minute. This will help clean any debris that might otherwise clog the system. Replace aerator.
- D. Operate handle up and down, in cold and hot positions, to flush water lines thoroughly.

### Maintenance:

Simply rinse the surface with clear water or mild liquid detergents (if necessary). Dry the faucet with a clean soft cotton cloth. Do not use any cleaning agents containing acids, polish abrasives, or harsh cleaners.

## Installation

### Step 1

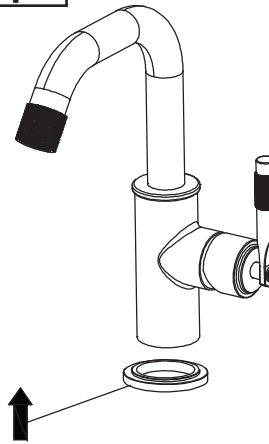

### Steps 2 and 3

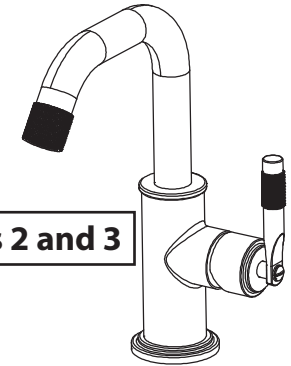

1 ↑

2 ↑

3 ↑

### Steps 4 to 6

4 ↓

5 ↑

6 ↑

