



***Freestanding Range
Gas Cooktop
Electric Oven***



**User Manual
&
Installation Instructions**

IMPORTANT SAFETY INSTRUCTIONS
Carefully read the important information
regarding installation, safety and maintenance.
Keep these instructions for future reference.

MAAN2221-01
2020-04-29

Before You Begin

INSTALLERS - Start Here

Safety Instructions are on pages 4 to 10 and Installation Instructions are on pages 11 to 23.

Please perform these steps:

1. Read the safety instructions.
2. Read all instructions in the Installation section of this manual BEFORE installing the range.
3. Remove all packing materials from the oven before connecting the gas supply.
4. Observe all governing codes and ordinances.
5. When finished, make sure to leave these instructions with the consumer.
6. Installation is only to be done by a qualified technician, but ultimately proper installation is the responsibility of the installer.
7. Product failure due to improper installation is not covered under the Warranty.



CONSUMERS - Start Here

Safety Instructions are on pages 24 to 26 and Operating Instructions are on pages 27 to 33.

Please perform these steps:

1. Read the safety instructions.
2. Read all instructions in the manual BEFORE operating the range.
3. Remove all packing materials from the oven before using.
4. Observe all governing codes and ordinances.
5. Installation is only to be done by a qualified technician, but ultimately proper installation is the responsibility of the installer.
6. Product failure due to improper installation is not covered under the Warranty.



Table of Contents

Before You Begin.....	2
Table of Contents	3
Important Safety Information	4
Installation	11
Pipe Selection	11
Included Parts	12
Tools and Additional Parts Needed.....	13
Range Dimensions	14
Step 1 - Read the Safety Precautions.....	15
Step 2 - Plan Desired Location, Unpack the Range and Prepare Tools	15
Step 3 - Install Leveling Feet and Backsplash	15
Step 4 - Gas Connection	16
Step 5 - Liquefied Petroleum (Propane) Gas Conversion	18
Adjusting the Regulator Pressure	18
Changing Burner Nozzles	19
Adjusting the Burner Flames	19
Testing Flame Stability	20
Electrical Specifications.....	20
Step 6 - Install Anti-Tip Bracket.....	21
Step 7 - Burner Rings and Caps Placement.....	22
Step 8 - Connect to AC.....	23
Safety Before Operating.....	24
Operation.....	27
Location of Controls.....	27
Setting the Clock.....	28
Setting the Timer.....	28
Oven Timed Cooking	28
Burners and Cookware	29
Burner Cooking.....	30
Oven Racks.....	30
Oven Controls	31
Oven Cooking Modes	31
Cooking Chart.....	33
Care and Maintenance	34
Removing the Oven Door.....	35
Replacing the Light Bulb.....	36
Adjusting the Burner Flames.....	36
Before Calling for Service.....	37

Important Safety Information

READ ALL INSTRUCTIONS BEFORE USE

Read and follow all instructions before using your oven to prevent the risk of fire, electric shock, personal injury, or damage when using the range. This guide does not cover all possible conditions that may occur. Always contact your service technician or manufacturer about problems that you do not understand.



DANGER: When you see this symbol in the instructions, it indicates a hazardous situation which, if not avoided, could result in death or serious injury.



WARNING: When you see this symbol in the instructions, it indicates a hazardous situation which, if not avoided, could result in minor or moderate injury.

WHAT TO DO IF YOU SMELL GAS



- Open all windows starting with those closest to the range.
- DO NOT try to light any appliance.
- DO NOT touch any electrical switch or outlet.
- DO NOT use any phone in your home/building.
- Immediately call your gas supplier from a neighbor's phone. Follow the gas supplier's instructions.
- If you cannot reach your gas supplier, call the fire department.

INSTALLATION



- Remove all tape and packaging before using the appliance. Never allow children to play with packaging material.
- Do not remove the model/serial plate attached to the appliance.
- Be sure your appliance is properly installed and grounded by a QUALIFIED TECHNICIAN in accordance with all local codes and ordinances and with the National Fuel Gas Code ANSI Z223.1—latest edition and the National Electrical Code ANSI/NFPA No. 70—latest edition in United States, or CAN/CGA B149.1, B149.2, and the Canadian Electrical Code, Part 1, in Canada.

Important Safety Information



WARNINGS

- Do not store or use gasoline or other flammable vapors and liquids in the vicinity of this or any other appliance.
- Gas leaks cannot always be detected by smell.
- Gas suppliers recommend that you use a gas detector approved by UL or CSA. For more information, contact your gas supplier.
- If a gas leak is detected, follow the “What to do if you smell gas” instructions on the previous page.
- Installation and service must be performed by a qualified installer, servicer or the gas supplier. Ask your dealer to recommend a qualified technician and an authorized repair service. Know how to shut off gas supply at the meter and disconnect the electrical power to the appliance at the circuit breaker or fuse box in case of an emergency. **Have the installer show you the location of the range gas shut-off valve and how to shut it off if necessary.**
- Do not repair or replace any part of the appliance unless specifically recommended in this manual. All other servicing should be done only by a qualified technician. This may reduce the risk of personal injury and damage to the appliance.
- **Proper Installation:** The range, when installed, must be electrically grounded in accordance with local codes or, in the absence of local codes, with the National Electrical Code, ANSI/NFPA 70. In Canada, the range must be electrically grounded in accordance with Canadian Electrical Code. Be sure the range is properly installed and grounded by a qualified technician.
- Disconnect power before servicing.
- Never modify or alter the construction of the appliance by removing panels, wire covers or any other part of the product.
- Injuries may result from the misuse of appliance doors or drawers such as stepping, leaning, or sitting on the doors or drawers.
- Overhead range hoods, which operate by blowing a downward air flow on to a range, shall not be used in conjunction with gas ranges other than when the hood and range have been designed, tested and listed by an independent test laboratory for use in combination with each other.
- If range is located near a window, NEVER hang long curtains or paper blinds on that window. They could blow over the surface burners and ignite, causing a fire hazard.
- Ensure that the room is well ventilated by keeping the air intakes open and in good working order or by installing an extractor hood with discharge pipe. If the appliance is used intensively for a long time the effectiveness of the ventilation will have to be increased, for example by opening a window or increasing the power of any electric extractor fan.
- Flammable materials should not be stored on the appliance or near surface units. This includes paper, plastic and cloth items, such as cookbooks, plastic ware and towels, as well as flammable liquids. Do not store explosives, such as aerosol cans, on or near the appliance. Flammable materials may explode and result in fire or property damage.
- **Maintenance:** Keep range area clear and free from combustible materials, gasoline, and other flammable vapors and liquids.
- **Storage in or on the Range:** Flammable materials should not be stored in an oven or near surface units.

IN THE STATE OF MASSACHUSETTS, THE FOLLOWING INSTALLATION INSTRUCTIONS APPLY:

- Installations and repairs must be performed by a qualified or licensed contractor, plumber, or gas-fitter qualified or licensed by the State of Massachusetts.
- If using a ball valve, it shall be a T-handle type.
- A flexible gas connector, when used, must not exceed three feet.

STATE OF CALIFORNIA PROPOSITION 65 WARNINGS:

- The California Safe Drinking Water and Toxic Enforcement Act requires the Governor of California to publish a list of substances known to the state to cause birth defects or other reproductive harm and requires businesses to warn customers of potential exposure to such substances.
- Gas appliances can cause minor exposure to three of these substances, namely, carbon monoxide, formaldehyde and soot, caused primarily by the incomplete combustion of natural gas or LP fuels. Properly adjusted burners, indicated by a bluish rather than yellow flame, will minimize incomplete combustion. Exposure to these substances can be minimized by venting with an open window or by using a ventilation fan or hood.

Important Safety Information

DANGER

- Do not store items of interest to children in the cabinets above the appliance or on the backsplash of a range. Children should not be left alone or unattended in the area where appliance is in use. Do not allow children to climb or play around the appliance. They should never be allowed to sit or stand on any part of the appliance. Children climbing on the appliance to reach items could be seriously injured.
- **DO NOT TOUCH THE COOKING SURFACE, THE BURNERS, GRATES, OR ANY AREAS NEAR THEM.** Surface burners or appliance may be hot even though flames are not visible. Areas near surface burners or appliance may become hot enough to cause burns. During and after use, do not touch, or let clothing or other flammable materials touch these areas until they have had sufficient time to cool.
- Do not wear loose-fitting or hanging garments while using the appliance. Do not let clothing or other flammable materials contact hot surfaces.
- Smother grease fires with a pan lid, or use baking soda, a dry chemical or foam-type extinguisher.
- Use an extinguisher ONLY if:
 - You know you have a Class A, B or C extinguisher, and you already know how to operate it.
 - The fire is small and contained in the area where it is started.
 - The fire department is being/has been called.
 - You can fight the fire with your back to an exit.
- When heating fat or grease, watch it closely. Fat or grease may catch fire if allowed to become too hot.
- Use only dry potholders. Moist or damp potholders on hot surfaces may result in burns from steam. Do not let potholders touch hot heating elements, the flame or burners. Do not use a towel or other bulky cloth instead of a potholder.
- Do not heat unopened food containers. Buildup of pressure may cause the container to burst and result in injury.
- Stepping, leaning or sitting on this appliance can result in serious injuries and also cause damage to the appliance.
- Never use this appliance as a space heater to heat or warm the room. Doing so may result in carbon monoxide poisoning and overheating of the oven.
- Know which knob controls which surface burner. Visually check that the burner has lit. Then adjust the flame so it does not extend beyond the edge of the pot/pan.
- Clean the appliance regularly to keep all parts free of grease that could catch fire. Exhaust fan ventilation hoods and grease filters should be kept clean. Do not allow grease to accumulate on hood or filter. Greasy deposits in the fan could catch fire. When cooking food, turn the hood fan on. Refer to hood manufacturer's instructions for cleaning.
- Pot/pan handles should be turned inward and not extend over adjacent surface burners. To reduce the risk of burns, ignition of flammable materials, and spillage due to unintentional contact with the pot/pan, the handle of the utensil should be positioned so that it is turned inward, and does not extend over adjacent surface burners.
- Never leave surface burners unattended at high heat settings. Boilovers cause smoke and greasy spillovers that may ignite, or a pan that has boiled dry may melt.
- Do not use aluminum foil to line any part of the appliance. Use aluminum foil only to cover food during cooking. Improper installation of these liners may result in risk of electric shock or fire.
- Only certain types of glass, glass/ceramic, ceramic, earthenware, or other glazed utensils are suitable for appliance service without breaking due to the sudden change in temperature. Check the manufacturer's recommendations for appliance use.
- Do not use decorative surface burner covers. If a burner is accidentally turned on, the decorative cover will become hot and possibly melt. You will not be able to see that the burner is on. Burns will occur if the hot covers are touched. Damage may also be done to the range or burners because the covers may cause overheating. Air will be blocked from the burner and cause combustion problems.
- Always use proper flame size. Adjust flame size so it does not extend beyond the edge of the pot/pan. The use of undersized pots/pans will expose a portion of the burner flame to direct contact and may result in ignition of clothing. Proper relationship of pot/pan to flame will also improve efficiency.
- Top burner flame size should be adjusted so it does not extend beyond the edge of the cooking utensil.

Important Safety Information

DANGER

- Use the proper pot/pan sizes. This appliance is equipped with surface units of different sizes. Select pots/pans having flat bottoms large enough to cover the surface unit. The use of undersized utensils will expose a portion of the surface heating unit to direct contact and may result in ignition of clothing. Proper relationship of utensil to the surface unit will also improve efficiency.
- Do not use stove top grills on your gas appliance. If you use a stove top grill on a sealed gas burner, it will cause incomplete combustion and can result in exposure to carbon monoxide levels above allowable current standards. This can be hazardous to your health.
- Remove all packaging materials from the range before operating it. These materials can ignite, causing smoke and/or fire damage.

TIPPING DANGER

- TIPPING RANGES CAN CAUSE SERIOUS PERSONAL INJURY OR DEATH.
- TO REDUCE THE RISK OF TIPPING OF THE RANGE, THE RANGE MUST BE SECURED WITH A PROPERLY INSTALLED ANTI-TIP DEVICE.
- FAILURE TO PROPERLY INSTALL THE ANTI-TIP BRACKET COULD RESULT IN THE DEATH OF A CHILD OR ADULT.
- To check if the device has been properly installed, slide range forward, look for anti-tip bracket securely attached to floor or wall then slide range back so rear range foot is under anti-tip bracket.
- Carefully pull on the range from the rear. If the bracket is installed correctly, the range will not tip more than 4 inches from the wall. If it tips forward more than 4 inches, the anti-tip device has not been installed correctly.
- CAUTION: DO NOT TIP THE RANGE MORE THAN 4 INCHES FROM THE WALL AS IT COULD TIP OVER AND CAUSE INJURY.
- If the range is pulled from the wall for any reason, always repeat this procedure to verify the range is properly secured by the anti-tip bracket.
- Never completely remove the leveling legs or the range will not be secured to the anti-tip device properly.
- NEVER step or sit on the door.
- The range will not tip during normal use. However, without a properly fastened anti-tip bracket, the range can tip if too much force or weight is applied to the open door.
- See page 21 for instructions on how to install the Anti-Tip Bracket.





VENTILATION WARNINGS

- The range should have proper ventilation in order to keep the unit operating properly and maintain the temperature of immediate surroundings within safe limits. Check your local building codes as they may vary from the general rules outlined in this guide.
- Observe all governing codes and ordinances. Do not obstruct flow of combustion and ventilation air.
- It is the installer's responsibility to comply with installation clearances specified on the model/serial rating plate.
- For proper operation of a gas appliance, the air necessary for the combustion of the gas must be able to flow into the room naturally. The air must flow into the room directly through openings in the outside walls. These openings must have an unobstructed cross-section not less than 2m³/h for each kw of power (see total power in kw on the appliance).
- This opening must be constructed so that it will not be obstructed from inside or outside, and not be constructed close to the floor. The opening is recommended to be on the side opposite to that on which the flue gases are discharged.
- The range should be located for convenient use in the kitchen.
- Recessed installations must provide complete enclosure of the sides and rear of the range.
- To eliminate the risk of burns or fire by reaching overheated surface units, cabinet storage space located above the surface units should be avoided. If cabinet storage is to be provided, the risk can be reduced by installing a range hood or microwave hood combination with minimum 400 CFM that projects horizontally a minimum of 5" (12.7 cm) beyond the bottom of the cabinets.
- If a range hood is installed above the appliance, maintain a 30" minimum clearance between cooking surface and bottom of range hood. The range hood must be connected directly to flues or to the outside.
- Avoid placing cabinetry directly above the appliance when possible. If cabinetry is used above the cooking surface, use cabinets no more than 13" deep. Make sure the wall coverings, countertop and cabinets around the appliance can withstand heat up to 200° F (93°C) generated by the appliance.
- Cabinet opening dimensions that are shown must be used. Given dimensions are minimum clearances.
- Working areas adjacent to the range should have 18" minimum clearance between countertop and cabinet bottom. (See Figure 1)
- All openings in the wall or floor where range is to be installed must be sealed.
- Contact a qualified floor covering installer to check that the floor covering can withstand at least 200°F (93°C).
- Use an insulated pad or 1/4" (0.64 cm) plywood under range if installing range over carpeting.
- The floor anti-tip bracket must be installed. To install the anti-tip bracket shipped with the range, see "Install Anti-Tip Bracket" section on page 21.
- Grounded electrical supply is required. See "Connect to AC" section on page 23, as well as the safety precautions on page 10.
- Proper gas supply connection must be available. See "Gas Connection" section on pages 16 and 17, as well as the safety precautions on page 9.

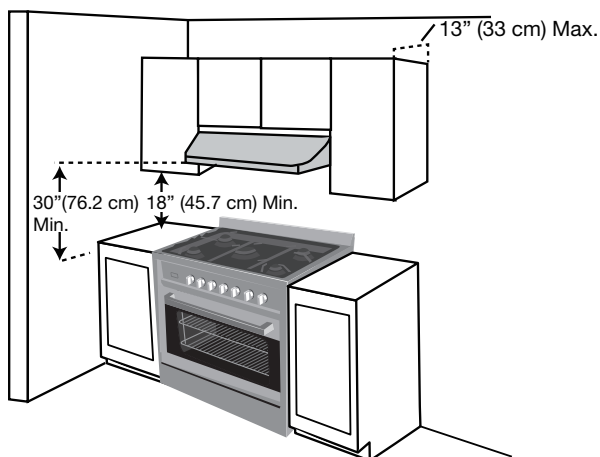

Figure 1

Important Safety Information



INSTALLATION WARNINGS

To avoid damage to your cabinets, check with your builder or cabinet supplier to make sure that the materials used will not discolor, delaminate or sustain other damage. This oven has been designed in accordance with the requirements of UL and CSA International and complies with the maximum allowable wood cabinet temperatures of 194°F (90°C).

MOBILE HOME – ADDITIONAL INSTALLATION REQUIREMENTS:

The installation of this range must conform to the Manufactured Home Construction and Safety Standard, Title 24 CFR, Part 3280 (formerly the Federal Standard for Mobile Home Construction and Safety, Title 24, HUD Part 280).

When such standard is not applicable, use the Standard for Manufactured Home Installations, ANSI A225.1/NFPA 501A or with local codes.

In Canada, the installation of this range must conform with the current standards CAN/CSA-A240-latest edition, or with local codes.

MOBILE HOME INSTALLATIONS REQUIRE:

When this range is installed in a mobile home, it must be secured to the floor during transit. Any method of securing the range is adequate as long as it conforms to the standards listed above.

GAS DANGER

Explosion hazard conditions will exist unless you perform ALL of the following:



- Use a new CSA International approved gas supply line.
- Install a shut-off valve.
- Securely tighten all gas connections.
- If connected to LP, have a qualified person make sure gas pressure does not exceed 14" (36 cm) water column.
- Examples of a qualified person include:
 - Licensed heating personnel
 - Authorized gas company personnel
 - Authorized service personnel

Failure to do so can result in death, explosion, or fire.

- Observe all governing codes and ordinances.

IMPORTANT: This installation must conform with all local codes and ordinances. In the absence of local codes, installation must conform with American National Standard, National Fuel Gas Code ANSI Z223.1 - latest edition, or CAN/CGA B149 - latest edition.

IMPORTANT: Leak testing of the range must be conducted according to the manufacturer's instructions.

- Provide a gas supply line of 3/4" (1.9 cm) rigid pipe to the range location. A smaller size pipe on longer runs may result in insufficient gas supply. Pipe-joint compounds that resist the action of LP gas must be used. Do not use TEFLON® tape. With LP gas, piping or tubing size must be 1/2" (1.3 cm) minimum. Usually, LP gas suppliers determine the size and materials used in the system.

- Gas supply should be located near the opening for this appliance and be a minimum of 1" from the back wall (See Figure 2):

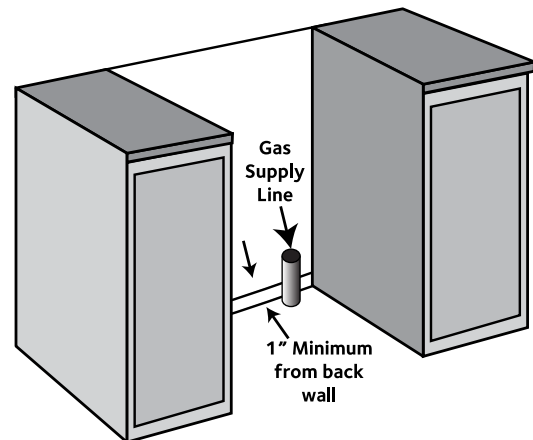

Figure 2

Types of Gas

NATURAL GAS:

- This range is designed for use with Natural gas or, after proper conversion, for use with LP gas.
- This range is factory set for use with Natural gas. The model/serial rating plate has information on the types of gas that can be used. If the types of gas listed do not include the type of gas available, check with the local gas supplier.

LP GAS CONVERSION:

- Conversion must be done by a qualified service technician.
- No attempt shall be made to convert the appliance from the gas specified on the model/serial rating plate for use with a different gas without consulting the serving gas supplier.



ELECTRICAL DANGER

Electrical Shock Hazard.

Do not use an extension cord.

Failure to follow these instructions can result in death, fire, or electrical shock.

- Any additions, changes or conversions required in order for this appliance to satisfactorily meet the application needs must be made by a qualified service technician in accordance with the manufacturer's instructions and all codes and requirements of the authority having jurisdiction. Failure to follow the instructions could result in serious injury or property damage. The qualified agency performing this work assumes responsibility for the conversion.
- DO NOT operate this appliance using a 2-prong adapter or an extension cord. If a 2-prong wall receptacle is the only available outlet, it is the personal responsibility of the consumer to have it replaced with a properly grounded 4-prong wall receptacle installed by a qualified electrician.
- Severe shock, or damage to the range may occur if the range is not installed by a qualified installer or electrician.
- This appliance features a pilot-less electric ignition for energy savings and reliability. It is 220-240V/50-60Hz. It is recommended to connect to a 50 Amp power supply.
- Total Input Power is 3.5 kw (14.59 A). A dedicated circuit, protected by a minimum 15 to 30 amp time delay fuse or circuit breaker is required.
- For personal safety, the appliance must be properly grounded.

Installation

Pipe Selection

OPTION 1: FLEXIBLE METAL APPLIANCE CONNECTOR:

- Never reuse old flexible connectors. The use of old flexible connectors can cause gas leakage and personal injury. Always use new flexible connectors when installing a gas appliance. To reduce the possibility of gas leakage, apply Teflon tape or a thread compound approved for use with LP or Natural gases to all threaded connections.
- If local codes permit, a new CSA design-certified, 4 to 5 ft (122 to 152.4 cm) long, 1/2" (1.3 cm) or 3/4" (1.9 cm) I.D., flexible metal appliance connector may be used for connecting range to the gas supply line.



A 1/2" (1.3 cm) male pipe thread/adaptor is needed for connection to the female pipe threads of the inlet to the appliance pressure regulator.

- Do not kink or damage the flexible metal tubing when moving the range.

OPTION 2: RIGID PIPE CONNECTOR:

- The rigid pipe connection requires a combination of pipe fittings to obtain an in-line connection to the range. The rigid pipe must be level with the range connection. All strains must be removed from the supply and fuel lines so range will be level and in line.

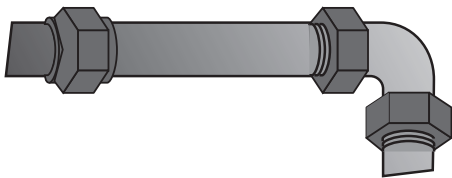

BURNER INPUT REQUIREMENTS:

- Input ratings shown on the model/serial rating plate are for elevations up to 2,000 ft (609.6 m).
- For elevations above 2,000 ft (609.6 m), ratings are reduced at a rate of 4% for each 1,000 ft (304.8 m) above sea level (not applicable for Canada).

MUST INCLUDE A SHUT-OFF VALVE:

- Be sure you know where and how to shut off the gas supply to the range.
- The supply line must be equipped with a manual shut-off valve. This valve should be located in the same room but external to the range in an easily accessible location. It should be in a location that allows ease of opening and closing. Do not block access to shut-off valve. The valve is for turning on or shutting off gas to the range. (See Figure 3)

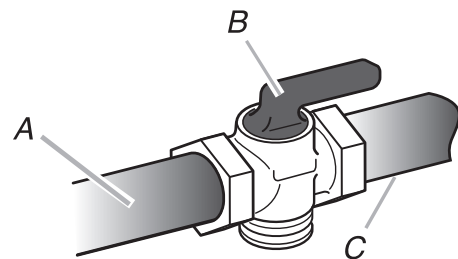

A. Gas supply line
B. Shutoff valve "open" position
C. To range

Figure 3

GAS SUPPLY PRESSURE TESTING:

Line pressure testing above 1/2 psi gauge (14" WCP):

- The range and its individual shut-off valve must be disconnected from the gas supply piping system during any pressure testing of that system at test pressures in excess of 1/2 psi (3.5 kPa).

Line pressure testing at 1/2 psi gauge (14" WCP) or lower:

- The range must be isolated from the gas supply piping system by closing its individual manual shut-off valve during any pressure testing of the gas supply piping system at test pressures equal to or less than 1/2 psi (3.5 kPa).

Installation

Included Parts

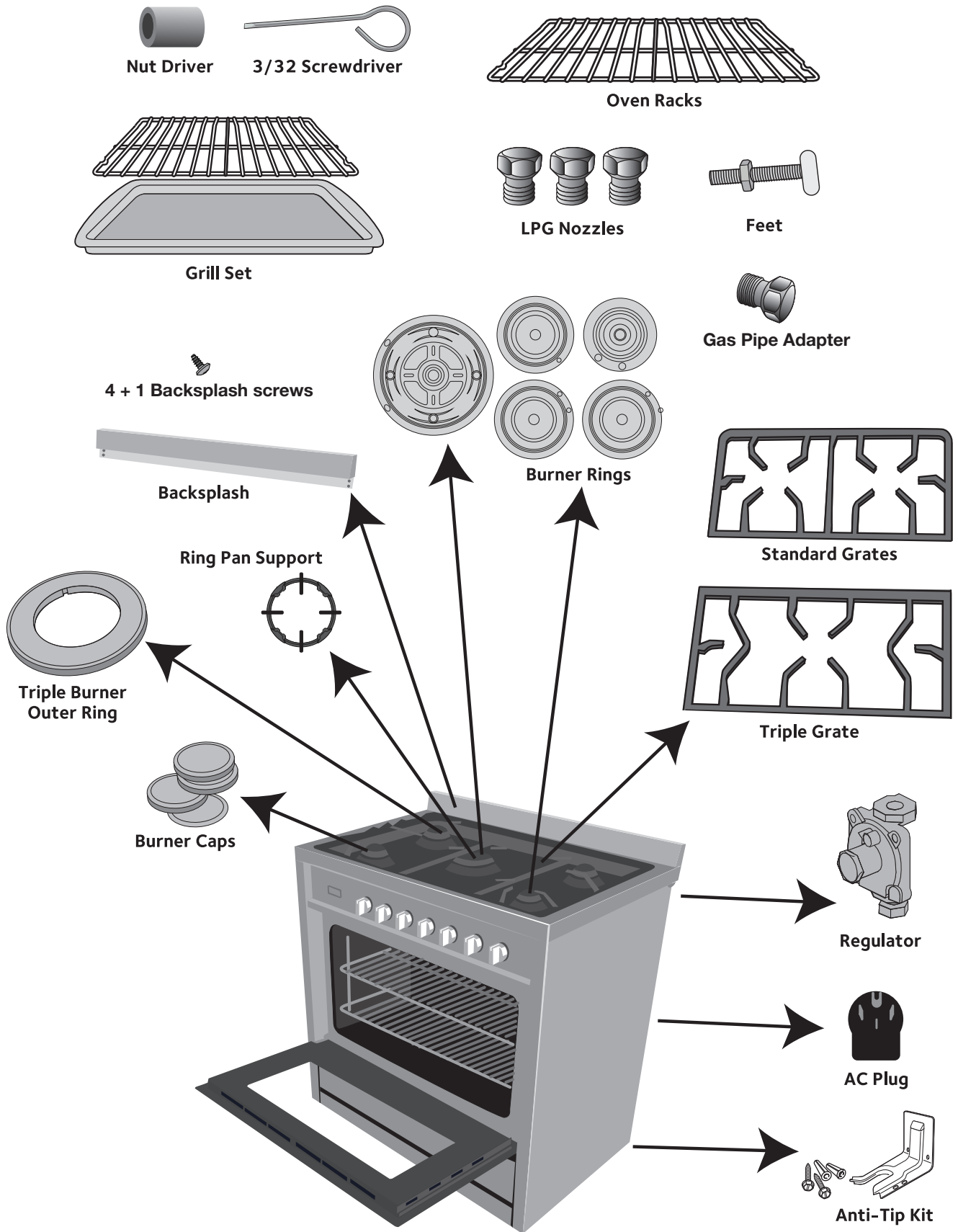

Installation

Tools and Additional Parts Needed



Tape measure



Phillips screwdriver



Flat blade screwdriver
1/8" flat blade screwdriver



Hex screwdriver

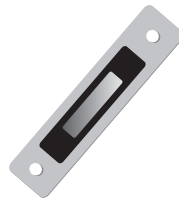

Level



Hand or electric drill



Wrench or pliers



Pipe wrench



15/16" combination wrench



1/8" (3.2 mm) drill bit (for wood floors)



Marker or pencil



Pipe-joint compound resistant to
LP gas



3/16" (4.8 mm) carbide-tipped masonry
drill bit (for concrete/ceramic floors)



Noncorrosive leak-detection solution

For Additional Parts:

Check local codes, consult gas supplier and check existing gas/electrical supply. See "Electrical Requirements" and "Gas Supply Requirements" sections.

Installation

Range Dimensions

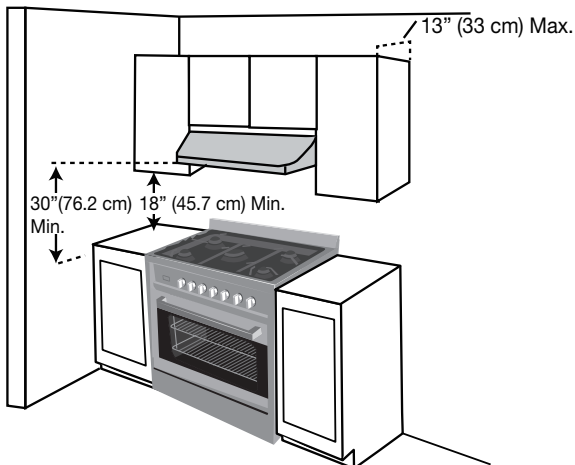
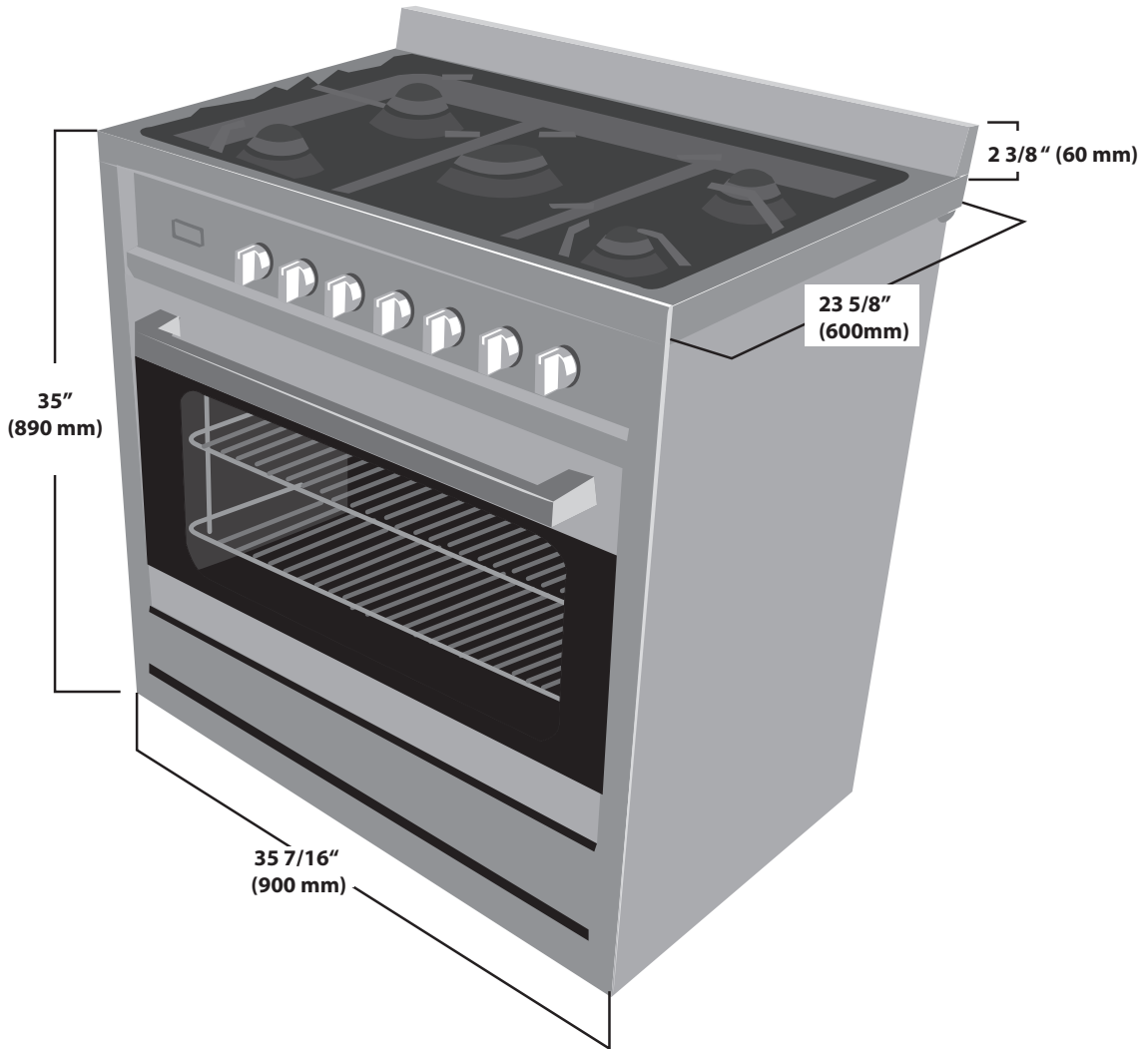

Figure 4

DANGER:

- Avoid placing cabinetry directly above the appliance when possible. If cabinetry is used above the cooking surface, use cabinets no more than 13" deep. Make sure the wall coverings, countertop and cabinets around the appliance can withstand heat up to 200° F (93°C) generated by the appliance.
- Cabinet opening dimensions that are shown must be used. Given dimensions are minimum clearances.
- Working areas adjacent to the range should have 18" minimum clearance between countertop and cabinet bottom.
- See Figure 4.

Installation

STEP 1

Read the Safety Precautions

Please read the safety precautions on pages 4 to 10. Safety instructions pertaining to each step have been outlined in the installation steps; however it is important to read **ALL** the safety instructions.

IMPORTANT: It is the installer's responsibility to comply with installation clearances.

STEP 2

Plan Desired Location, Unpack the Range and Prepare Tools

Plan a desirable location that fits all requirements in the Safety and Install sections of this manual. Unpack the range and parts carefully (including the parts contained in the oven cavity) and make sure all parts are included as shown on page 12. Assemble all tools as shown on page 13. **DO NOT** remove the protective film covering the appliance or remove the tape securing the drawer.

STEP 3

Install Leveling Feet and Backsplash

1 Remove the four L-shaped cardboard corner protectors from the carton and stack them on top of one another. Place them on the floor and using two people, carefully lay the range on its back using the cardboard corners to hold them up.

2 Install the leveling feet one at a time. (See Figure 5)

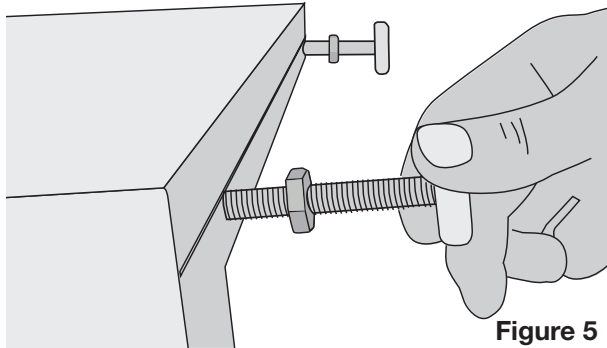

Figure 5

3 Place a protector on the floor such as flat cardboard and using two people, stand the range upright onto the protector.

4 Remove the protective film covering the appliance and the tape securing the drawer.

5 If range height adjustment is necessary, use a wrench to loosen the four leveling feet and adjust as necessary, using a level for best results. If height adjustment is made when range is standing, tilt the range back to adjust the front legs, then tilt forward to adjust the rear legs. (See Figure 6)

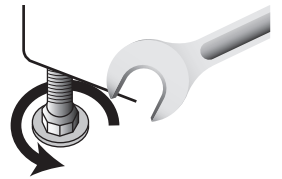

Figure 6

6 (Optional Step) Align backsplash holes with holes at the edge of the stovetop, which extends past the back of the oven. (See Figure 7)

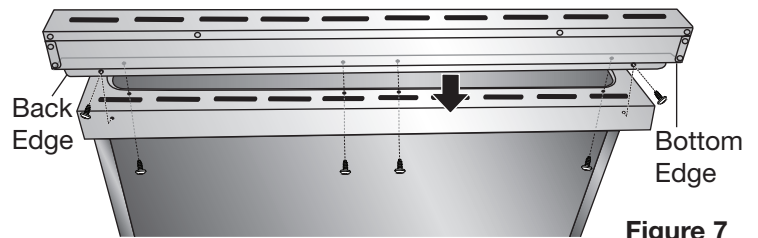

Figure 7

7 With one person holding the backsplash and working from underneath the extended rear edge, insert screws through the bottom of the backsplash. Tighten completely.

8 Insert the two screws on each side, through the back edge of the backsplash and into the cooktop. Tighten completely.

WARNINGS:



- Please make sure to read ALL safety precautions on pages 4 to 10.
- Use two or more people to move and install range.
- A child or adult can tip the range and be killed.
- Failure to follow these instructions can result in death or serious burns to children and adults.

Installation

STEP 4

Gas Connection

WARNINGS:  

- Please make sure to read ALL safety precautions on pages 4 to 10.
- Explosion Hazard.
- Use a new CSA International approved gas supply line.
- Install a shut-off valve.
- Securely tighten all gas connections.
- If connected to LP, have a qualified person make sure gas pressure does not exceed 14" (36 cm) water column. Examples of a qualified person include: licensed heating personnel, authorized gas company personnel, and authorized service personnel.
- Failure to do so can result in death, explosion, or fire.

DANGER: 

- This appliance is outfitted from the factory to be used with ONLY one type of gas. This range is to be connected with a gas supply line. The gas connection is a male 1/2" NPT and is located roughly 2-1/4" from the in from the right hand side of the appliance and 22" from the ground. The hose must be free of kinks or other deformations that would inhibit its ability to supply gas to the unit or cause a gas leak. Keep gas line s free from contact with any moving parts such as a drawer to prevent damage or obstruction.

1

INSTALL THE PRESSURE REGULATOR: This appliance is set for natural gas and is designed to operate at 5" water column pressure. The gas supply is required to provide a minimum of 4" to a maximum of 14" water column pressure to the appliance regulator. The pressure regulator must be connected in series with the manifold of the appliance and must remain in series with the supply line regardless the type of gas being used.

For proper operation, the gas pressure regulator supplied with this range must be used. The inlet pressure to the regulator should be as shown in the chart below.

NATURAL GAS

NATURAL GAS NOZZLES					
BURNER	POSITION	NOZZLE DIAMETER	MINIMUM PRESSURE	MAXIMUM PRESSURE	RATE (BTU/H)
Auxiliary	Front Right	1 x 1.10	4"	14"	5,000
Semi-Rapid	Rear Left & Right	1 x 1.29	4"	14"	7,000
Rapid	Front Left	1 x 1.45	4"	14"	8,500
Triple Ring	Center	5 x 0.99	4"	14"	18,000

If the appliance is converted for liquid petroleum (LP) gas, the LP gas supply is required to provide a minimum of 10" to a maximum of 14" water column to the cooktop regulator.

LIQUID PRETROLEUM (LP) GAS

LIQUID PRETROLEUM (LP) GAS NOZZLES					
BURNER	POSITION	NOZZLE DIAMETER	MINIMUM PRESSURE	MAXIMUM PRESSURE	RATE (BTU/H)
Auxiliary	Front Right	1 x 0.70	10"	14"	4,800
Semi-Rapid	Rear Left & Right	1 x 0.80	10"	14"	6,500
Rapid	Front Left	1 x 0.91	10"	14"	8,500
Triple Ring	Center	5 x 0.56	10"	14"	15,500

DANGER: 

The gas supply line must be equipped with an approved manual shut-off valve. The shut-off valve must be in an easily accessible location in the same room as the appliance. Do not block access to the shut-off valve. Be sure you know how and where to shut off the gas supply to the range.

Installation

STEP 4 (Continued)

Gas Connection

- 2** Shut off the gas supply valve before removing the old range and leave it off until the new hook-up has been completed. (See Figure 8)

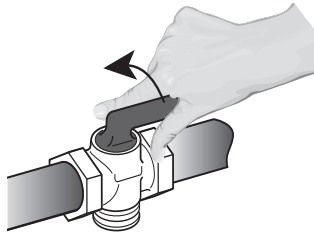

Figure 8

- 3** The gas inlet is located 6" down from the top of the appliance at the rear, right side and 2-1/2" in from the right hand side of the appliance. Make gas connection through rear wall, or on cabinet floor at rear. Install the house gas supply at least 1" from the back wall. Ensure a safety valve is fitted at the end of the pipeline.

- 4** The appliance leaves the factory tested and set for natural gas. Make sure that the type of gas to be supplied to the appliance is the same as that shown on the label affixed to the rear of the appliance. **Pressure Regulator is marked with an arrow; point this arrow towards the unit.**

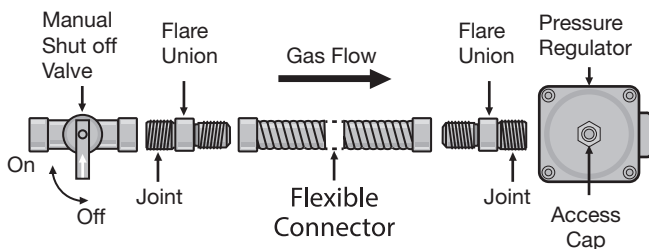

Figure 9

- 5** Attach one adapter/flare union to the gas pressure regulator and the other adapter/flare union to the gas shut-off valve. Tighten both adapters. (See Figure 9)

- 6** Attach the flexible pipe (see page 11 for pipe selection) to the adapters (see figure above).
If metal hoses are used, make sure they do not come into contact with mobile parts and are not crushed. Make sure to use a pipe-joint compound that is made for use with LP gas to the smaller thread ends of the adapters.

The gas intake connection of the appliance has a "male thread." When making the connection, take care not to apply stresses of any kind to the appliance. Over-tightening may crack the regulator resulting in a gas leak and possible fire or explosion.

- 7** After connecting the appliance to the gas supply, make sure all burners knobs are in the OFF position. Once regulator is in place, open the shut-off valve in the gas supply line. Wait a few minutes for gas to move through the gas line. (See Figure 10)

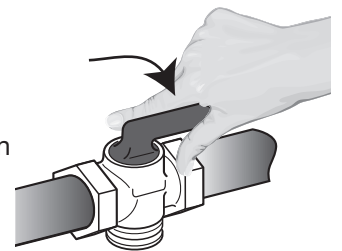

Figure 10

- 8** Check the system for leaks with a manometer. If a manometer is not available, turn on the gas supply and use a liquid leak detector (or soap and water) at all joints and connections to check for leaks.

DANGER:

- Please make sure to read ALL safety precautions on pages 4 to 10.
- Do not use a flame to check for leaks from gas connections. Checking for leaks with a flame may result in a fire or explosion.
- Tighten all connections if necessary to prevent gas leakage in the range or supply line.
- Check alignment of control knob valves after connecting the range to the gas supply to be sure the range manifold pipe has not moved. A misalignment could cause the valve stems to rub on the control panel, resulting in a gas leak at the valve.
- Disconnect this range and its individual manual shut-off valve from the gas supply piping system during any pressure testing of that system at test pressures in excess of 1/2 psi (3.5 kPa or 14" water column).
- Isolate the range from the gas supply piping system by closing its individual manual shut-off valve during any pressure testing of the gas supply piping system at test pressures equal to or less than 1/2 psi (3.5 kPa or 14" water column).

Installation

STEP 5 (Optional)

(Must be done before Step 6 if converting to Propane)

Liquefied Petroleum (Propane) Gas Conversion

This appliance can be used with Natural Gas or LP/Propane Gas. It is shipped from the factory for use with Natural Gas. A kit for converting to LP gas is supplied with your appliance. The kit is marked "FOR LP/PROPANE GAS CONVERSION".

WARNINGS:

- Please make sure to read ALL safety precautions on pages 4 to 10.
- Failure to make the appropriate conversion after Step 4 can result in serious personal injury and property damage.
- The conversion must be performed by a qualified service technician in accordance with the kit instructions and all local codes and requirements. Failure to follow instructions could result in serious injury or property damage. The qualified agency performing this work assumes responsibility for the conversion.

- 4** Remove retainer pin by pulling it out. (See Figure 13)

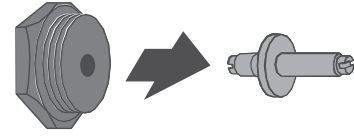

Figure 13

- 5** Reverse the retainer pin and snap it back into the regulator cap. (See Figure 14)

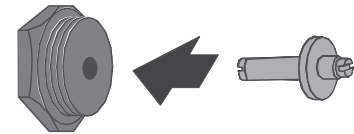

Figure 14

- 6** Screw the regulator cap back into the regulator and re-attach it to the nipple and flare union as shown. DO NOT over-tighten. (See Figures 15 and 16)

- 1** When the range is converted for Liquid Petroleum (LP) Gas, the LP gas supply is required to provide a minimum of 10" to a maximum of 14" water column to the range regulator. Following LP Gas Conversion, complete Steps 2 to 14: "Adjusting the Regulator Pressure"; "Changing Burner Nozzles"; "Adjusting Burner Flames"; and "Testing Flame Stability".

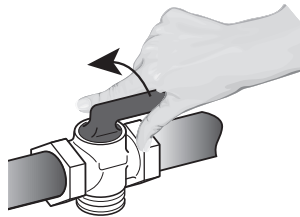

Figure 11

Adjusting the Regulator Pressure

- 2** Shut off the gas supply to the appliance by closing the manual shut-off valve. (See Figure 11)

- 3** Unscrew the regulator cap with a wrench. (See Figure 12)

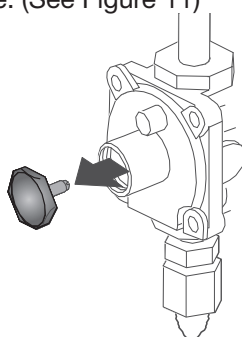

Figure 12

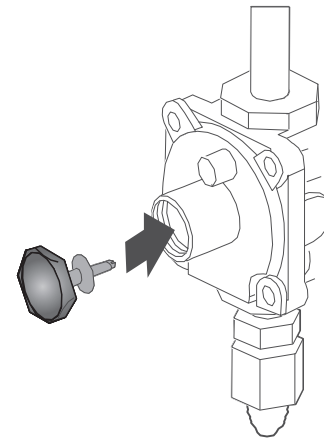

Figure 15

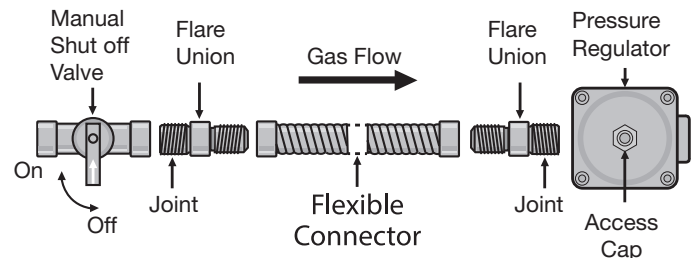

Figure 16

Installation

STEP 5 (Continued)

Liquefied Petroleum (Propane) Gas Conversion

Changing Burner Nozzles

INSTALLATION TIP: To prevent any omissions, remove ALL existing Natural Gas nozzles before replacing them with the LP nozzles.

7 Remove the burner grates, burner caps and burner rings. Using the provided 7mm nut driver, remove ALL the existing Natural Gas burner nozzles. Carefully read and observe each nozzle label for correct location (DO NOT force or over-tighten nozzles as doing so will damage the burner base and affect the flame).

8 Install the proper nozzles in the exact locations as noted in the illustrations and the table below. (See Figures 17 and 18)

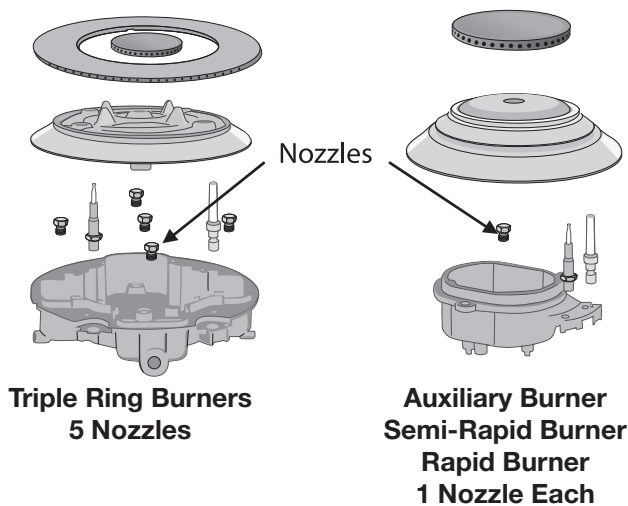

Figure 17

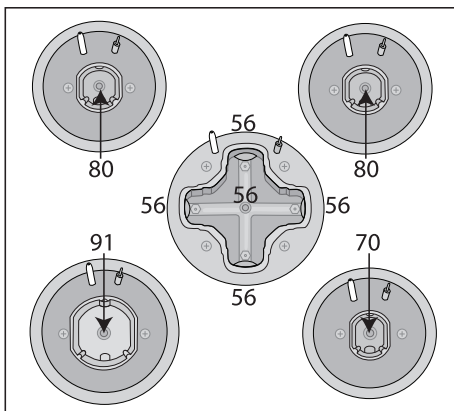

Figure 18

Adjusting the Burner Flames

9 Ensure electricity and gas are switched on. Turn all burners to their highest settings. Flames should be blue in color (LP gas flames may have yellow tips). Foreign particles in the gas line may cause an orange flame at first, but this will soon disappear.

10 Check each cooktop burner for proper low flame: Push and turn burner knob to Low (🔻); the flame size should be 1/4" to 3/8" (0.64 cm to 0.95 cm) high. (See Figure 19)

11 Set two other burners to "Medium". This will prevent the upper row of flames from being set too low resulting in the flame being extinguished when the other burners are turned on.

12 To adjust the flame, remove the knobs; insert the included 3/32 screwdriver through the access hole to engage the brass slotted screw as shown (See Figure 20). Slowly turn the screw counter-clockwise to lower the flame and clockwise to increase the flame.

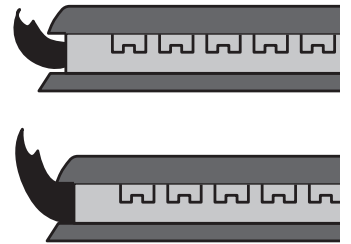

A. Low flame
B. High flame

Note: If burner does not stay ignited at low setting, return burner knob to "OFF" position then push and turn burner knob to "Medium" setting and adjust the flame slightly higher. Return burner knob to "OFF" position then re-check flame height at Low setting.

Figure 19

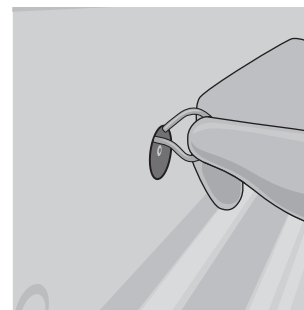

Figure 20

Installation

STEP 5 (Continued)

Liquefied Petroleum (Propane) Gas Conversion

LIQUID PETROLEUM (LP) GAS NOZZLES					
BURNER	POSITION	NOZZLE DIAMETER	MINIMUM PRESSURE	MAXIMUM PRESSURE	RATE (BTU/H)
Auxiliary	Front Right	1 x 0.70	10"	14"	4,800
Semi-Rapid	Rear Left & Right	1 x 0.80	10"	14"	6,500
Rapid	Front Left	1 x 0.91	10"	14"	8,500
Triple Ring	Center	5 x 0.56	10"	14"	15,500

Testing Flame Stability

13 **Test 1:** Turn a burner knob from High (🔥) to Low (🔥) quickly. If the upper row of flames goes out at this setting, increase the flame size and test again. Repeat for all burners.

Test 2: With a burner knob set to Low (🔥), open and close the cabinet door under the range. If the flame is extinguished by the air currents created by the door movement, increase the flame height and test again. Repeat for all burners.

14 After the adjustment is made, turn all burners off. Ignite each burner individually. Observe the flame with each burner knob in the High (🔥) position. Rotate the knob to the lowest setting and make sure that the flame size decreases as the knob is rotated counter-clockwise.

Adjust the height of top burner flames. When a burner knob is set to Low (🔥), the burner flame should be a steady blue flame approximately 1/4" (0.64 cm) over burner cap.

WARNING: 

Once the conversion has been completed and has passed testing, fill out the conversion sticker and include your name, organization and the date conversion is made. Apply the sticker near the appliance gas inlet opening to alert others in the future that this appliance has been converted. If converting back to Natural Gas, please remove the sticker so others know that the appliance is set to use its original gas.

Electrical Specifications

ELECTRICAL SPECIFICATIONS	
SYSTEM	WATTAGE
Oven Light	3 x 25 W
Upper Heating Element	2395 W
Bottom Heating Element	1960 W
Grill Heating Element	3158 W
Convection Heating Element	2 x 1250 W
Ventilator Motor	2 x 20 W
Cooling Fan	22.5 W

Installation

STEP 6

Install Anti-Tip Bracket

To reduce the risk of tipping of the range, the range must be secured to the floor with a properly installed Anti-Tip Bracket (included).

Failure to install the Anti-Tip Bracket will allow the range to tip over if excessive weight is placed on an open door or if a child climbs upon it. Serious injury might result from spilled hot liquids or from the range itself. If range is ever moved to a different location, the Anti-Tip Bracket must be re-installed.

1 Contact a qualified floor covering installer for the procedure of drilling mounting holes through your type of floor covering.

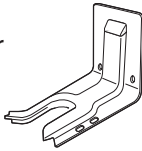

2 The Anti-Tip Bracket is to be installed to secure the range to the floor, follow these steps before moving the range into final operating position.

IMPORTANT: Determine the final location of the range before attempting to install the bracket.

3 Place the bracket on the floor with the back edge against the rear wall. If the range does not reach the rear wall, align the back edge of the bracket with the rear panel of the range in its final location.

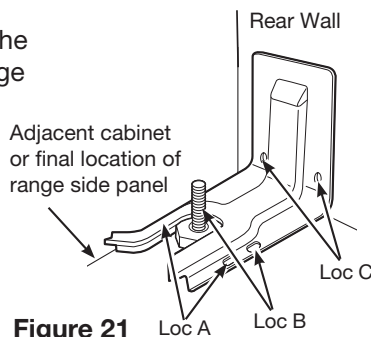

Figure 21



If bracket does not touch the rear wall, you **MUST** screw bracket to FLOOR as described in Step 6.

4 Position the side of the bracket against either the left or right cabinet. If there is no adjacent cabinet, align the edge of the bracket with the side panel of the range in its final location. If the countertop overhangs the cabinet, offset the bracket from the cabinet by the amount of overhang.

5 Mark the location for the pair of holes to be used (see Figure 21).
NOTE: For FLOOR installation use either Loc A or B. For REAR WALL installation use Loc C.

6 The bracket must be screwed to either the FLOOR or REAR WALL.

Attachment to Floor or Rear Wall

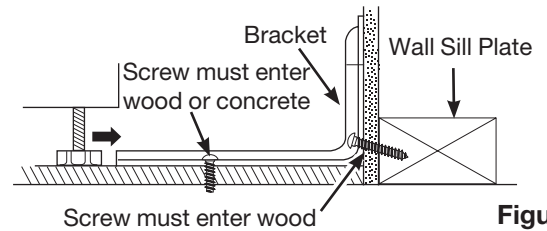

Figure 22

FLOOR Installation:

WOOD FLOOR: Use the screws provided to secure the bracket using the pair of marked holes (either Loc A or B).

CONCRETE FLOOR: Using a concrete bit, drill a 5/32" pilot hole 2" deep into the concrete at the center of each of the marked holes (either Loc A or B). Use the screws provided to secure the bracket into the floor.

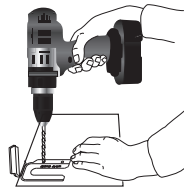

Figure 23

REAR WALL Installation:

Use the 2 screws provided to secure the bracket using the pair of marked holes at Loc C. The screws **MUST** enter into a wood sill plate. If the wall contains any metal studs or similar materials, then the floor must be used.

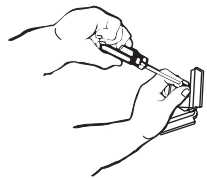

Figure 24

7 After installing the bracket, slide the range into its final location. The rear leveling leg must be fully inserted into the ANTI-TIP bracket as shown in Step 3. To check if the bracket is installed and engaged properly, look underneath the range to see that the rear leveling leg is engaged in the bracket. On some models, the storage drawer or kick panel can be removed for easier inspection. If visual inspection is not possible, slide the range forward, confirm the anti-tip bracket is securely attached to the floor or wall, and slide the range back so the leveling leg is under the anti-tip bracket. If the range is pulled from the wall for any reason, always repeat this procedure to verify the range is properly secured by the anti-tip bracket.

WARNINGS:



- Please make sure to read ALL safety precautions on pages 4 to 10.
- Use two or more people to move and install range.
- Tip-over Hazard, a child or adult can tip the range and be killed.
- Connect anti-tip bracket to rear range foot.
- Reconnect the anti-tip bracket, if the range is moved.
- The anti-tip bracket must be PROPERLY INSTALLED and the rear leveling leg must be FULLY ENGAGED into the bracket.
- NEVER remove the leveling legs.
- Failure to follow these instructions can result in death or serious burns to children and adults.

Installation

STEP 7

Burner Rings and Caps Placement

- 1** See below for Location of the Burners, as well as the illustrations of the burner caps and heads. (See Figure 25)

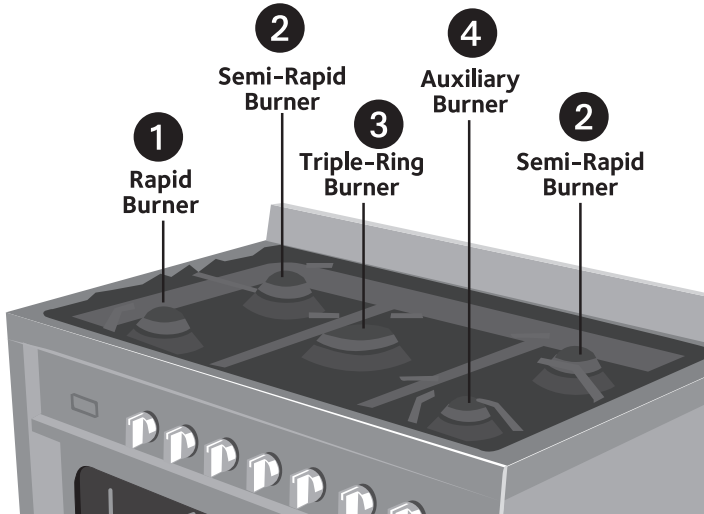

- 1. Rapid burner (Front left) – 8,500 BTU** **Figure 25**
2. Semi-rapid burners (Rear left and right) – 7,000 BTU
3. Triple-ring burner – (Center) 18,000 BTU
4. Auxiliary burner (Front right) - 5,000 BTU

- 2** Place each burner cap on the matching burner ring. The cap for each burner has an inner locating ring which centers the cap correctly on the burner ring. Be sure that all the burner caps and burner rings are correctly placed BEFORE using your appliance. (See Figure 26)

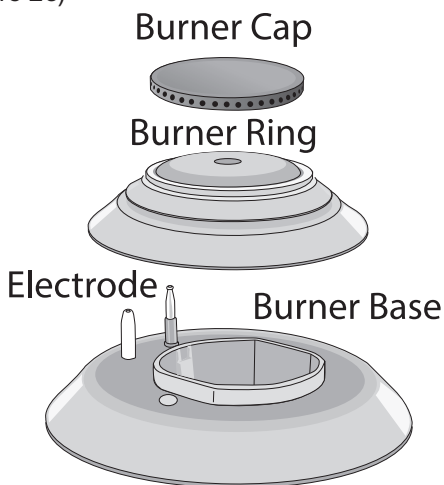
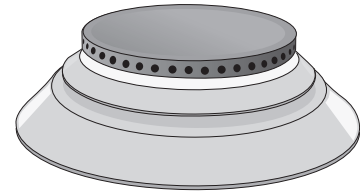
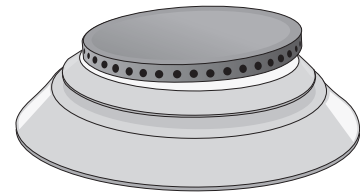

Figure 26

- 3** Make sure each burner cap is properly aligned and level, then place the two grates and one triple ring grate over the burners. (See Figure 27)



Burner Cap properly seated



Burner Cap not properly seated

Figure 27

- 4** Test operation of the electric igniters **after the range and supply line have been carefully checked for leaks and the range has been connected to the electrical power (see page 23)**. Push and turn a burner until clicking is heard. All five ignition pins will spark, but only the open valve will ignite.

- 5** Insert the oven racks. (See Figure 28)

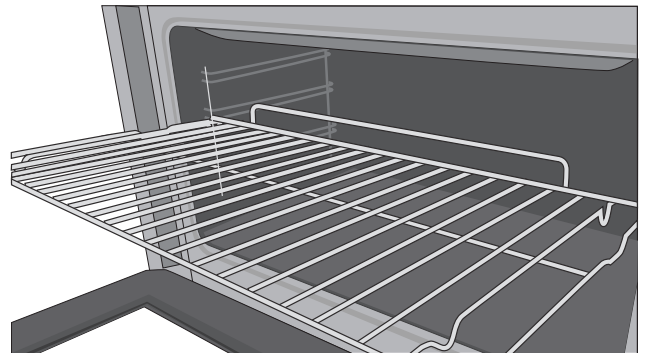

Figure 28

WARNINGS:

- Please read ALL safety precautions on pages 4 to 10.
- Do not service the sealed burner yourself. Contact a qualified service professional.
- The electrode of the electronic ignition system is positioned above the surface of the burner base. **Do not remove a burner cap or touch the electrode of a burner while another is turned on.** Damage or electrical shock may occur.

Installation

STEP 8

Connect to AC

DANGER: 

- Please make sure to read ALL safety precautions on pages 4 to 10.
- Electrical Shock Hazard.
- Do not use an adapter.
- Do not use an extension cord.
- Failure to follow these instructions can result in death, fire, or electrical shock.
- Electrical connection must be performed by a qualified service technician in accordance with the kit instructions and all local codes and requirements.
- The safety circuit-breaker and the electrical system must be able to withstand the load of the appliance. See rating label on back of range.
- Rating plate is located on back of range should you need to verify any of the electrical requirements.
- The power supply system should have a ground connection in good working order in accordance with the regulations in force.
- The electrical socket must be easily accessible with the appliance installed. In all cases, the power supply lead must be positioned so that it does not reach a temperature of 50°C (122°F) above the room temperature at any point.
- The manufacturer is not liable for any direct or indirect damage caused by faulty installation or connection. It is therefore necessary that all installation and connection operations are carried out by qualified personnel, complying with the local and general regulations in force.

Connecting to the AC Plug

- 1 Units include standard NEMA 14-50P plug. (See Figure 29)

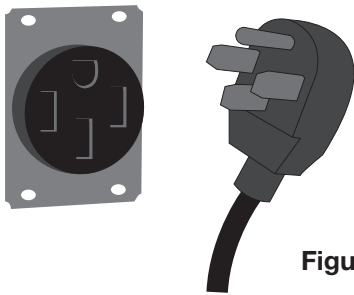

Figure 29

Connecting Directly to the Wall

- 1 Remove plate from the rear end of the Range. Unscrew the two screws and set aside. (See Figure 30)

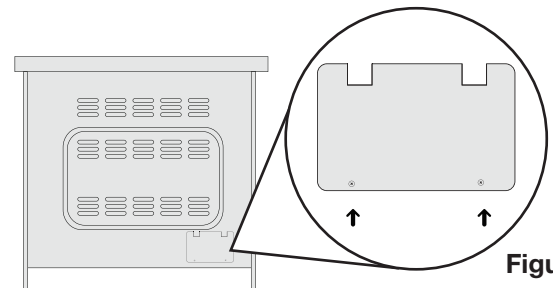

Figure 30

WARNING: 

- Never use reductions, shunts, or adapters which can cause overheating or burning.
- Make sure the AC Supply cable does not come in contact with any parts or components that get hot.

- 2 Open push out hole. Disconnect cables and insert through hole. (See Figure 31 A)
- 3 Connect cable with conduit and connect tube. Screw tightly on each side of part. (See Figure 31 B)

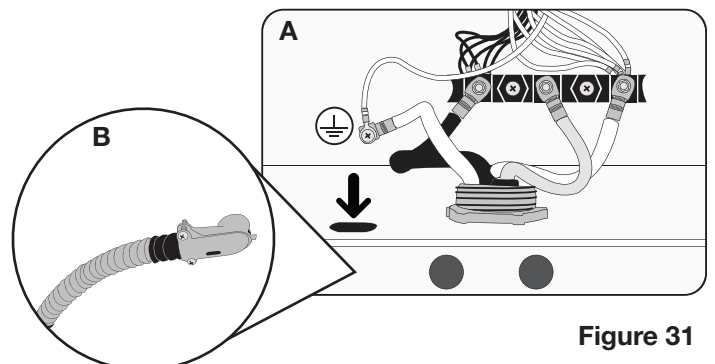

Figure 31

Safety Before Operating

Safety Precautions

Before operating this appliance it is VERY important that you read the safety precautions on pages 4 to 10 as well as all safety precautions listed on this and the following pages with the header, “**Safety Before Operating**”.

- Make sure your range is properly adjusted by a qualified service technician or installer for the type of gas (natural or LP) that is to be used. Your range can be converted for use with either type of gas. See the installation instructions section in this manual. These adjustments must be done by a qualified service technician according to the manufacturer’s instructions and all codes and requirements of the authority having jurisdiction. Failure to follow these instructions could result in serious injury or property damage. The qualified agency performing this work assumes responsibility for the conversion.
- Long term use of your range can result in high floor temperatures which could harm many types of floor coverings. Never install the range over vinyl tile or linoleum that is not specifically designed to withstand high temperatures. Never install it directly over interior kitchen carpeting.
- Items of interest to children should not be placed in cabinets above a range or on the backsplash of a range—children climbing on the range to reach items could be seriously injured.
- **DO NOT** leave children alone or unattended where a range is hot or in operation. They could be seriously burned.
- **DO NOT** let anyone climb, stand or hang on the oven door, warming drawer or cooktop. They could damage the range or cause it to tip over which could result in severe personal injury.
- NEVER use your range as a space heater to heat or warm the room. Doing so may result in carbon monoxide poisoning and overheating of the oven.
- NEVER wear loose fitting or hanging garments while using the appliance. Be careful when reaching for items placed in cabinets over the range. Flammable material could be ignited if brought in contact with flame or hot oven surfaces and may cause severe burns.
- **DO NOT** place flammable materials in an oven, a warming drawer or near a cooktop.
- **DO NOT** place or use combustible materials such as gasoline or other flammable vapors and liquids in the vicinity of this or any other appliance.
- **DO NOT** allow cooking grease or other flammable materials in or near the range.
- **DO NOT** use water on grease fires. Never touch a flaming pan. Turn the controls off. Smother a flaming pan on a surface burner by covering the pan completely with a well-fitting lid, cookie sheet or flat tray. A grease fire can be put out by covering it with baking soda or, if available, by using a multi-purpose dry chemical or foam-type fire extinguisher. Flame in the upper oven or lower oven drawer can be smothered completely by closing the oven door or drawer and turning the control to off, or by using a multi-purpose dry chemical or foam-type fire extinguisher.
- **DO NOT** use the oven or the drawer for storage.
- Allow the burner grates and other surfaces to cool before touching them.
- NEVER block the vents (air holes) of the range. They provide the air inlet and outlet that are necessary for the range to operate properly with correct combustion. Air openings are located at the rear of the cooktop, at the top and bottom of the oven door, and at the bottom of the range under the warming drawer.
- Stepping, leaning or sitting on the doors or drawers of this range can result in serious injuries and also cause damage to the range. **DO NOT** allow children to climb or play around the range. The weight of a child on an open door may cause the range to tip, resulting in serious burns or other injury.
- Leak testing of the appliance shall be conducted according to the manufacturer’s instructions.
- Make sure your range is properly installed and grounded by a qualified installer, according to the installation instructions. Any adjustment and service should be performed only by qualified gas range installers or service technicians.
- To prevent poor air circulation, place the range out of kitchen traffic path and out of drafty locations.
- **DO NOT** attempt to repair or replace any part of your range unless it is specifically mentioned in this manual. All other service should be referred to a qualified technician.
- Make sure all packaging materials are removed from the range before operating it to prevent fire or smoke damage should the packaging material ignite.

Safety Before Operating

Surface Burner Safety

WARNINGS:

- If the top burner flame goes out, gas will continue to flow to the burner until the knob is turned to the OFF position.
 - Do not leave the burners ON unattended.
 - Use proper pot/pan size—DO NOT use pans that are unstable or easily tipped. Select cookware having flat bottoms and large enough to cover burner grates. To avoid spillovers, make sure cookware is large enough to contain the food properly. This will save both cleaning time and prevent hazardous accumulations of food which could ignite if left on the range. Use pans with handles that can be easily grasped and remain cool.
- NEVER leave the surface burners unattended at high flame settings. Boilovers cause smoking and greasy spillovers that may catch on fire.
 - Always turn the burner knob to the Ignite (★) position when igniting the top burners and make sure the burners have ignited.
 - Control the top burner flame size so it does not extend beyond the edge of the cookware. Excessive flame is hazardous.
 - Use only dry pot holders—moist or damp pot holders on hot surfaces may result in burns from steam. **DO NOT** let pot holders come near open flames when lifting cookware. **DO NOT** use a towel or other bulky cloth instead of a pot holder.
 - When using glass cookware—make sure it is designed for top-of-range cooking.
 - To prevent burns, ignition of flammable materials and spillage, cookware handles should be turned toward the side or back of the range and should not extend over adjacent burners.
 - NEVER place any items on the cooktop. The hot air from the vent may ignite flammable items and will increase pressure in closed containers, which may cause them to burst.
 - Carefully watch foods being fried at a high flame setting.
 - Always heat fat slowly, and watch as it heats.
 - If frying combinations of oils and fats, stir together before heating.
 - Use a deep fat thermometer if possible to prevent overheating fat beyond the smoking point.
- Use the least possible amount of fat for effective shallow or deep-fat frying. Filling the pan too full of fat can cause spillovers when food is added.
 - **DO NOT** cook foods directly on the flame (without a pot or pan), use proper cookware.
 - **DO NOT** use a wok on the surface burners if the wok has a round metal ring that is placed over the burner grate to support the wok. This ring acts as a heat trap, which may damage the burner grate and burner ring. Also, it may cause the burner to work improperly and may cause a carbon monoxide level above that allowed by current standards, resulting in a health hazard.
 - Foods for frying should be as dry as possible. Frost or moisture on foods can cause hot fat to bubble up and spill over the sides of the pan.
 - NEVER try to move a pan of hot fat, especially a deep fat fryer. Wait until the fat is cool.
 - **DO NOT** place plastic items on the cooktop—they may melt if left too close to the vent.
 - Keep all plastics away from the surface burners.
 - To prevent burns, always be sure that the Burner knobs are in the OFF position and all grates are cool before attempting to remove them.
 - If you smell gas, turn off the gas to the range and call a qualified service technician. Never use an open flame to locate a leak.
 - Always turn Burner knob to the OFF position before removing cookware.
 - **DO NOT** lift the cooktop. Lifting the cooktop can cause damage and improper operation of the range.
 - If range is located near a window, **DO NOT** hang long curtains that could blow over the surface burners and catch on fire.
 - **DO NOT** operate the burner for an extended period of time without cookware on the grate. The finish on the grate may chip without cookware to absorb the heat.
 - Always use utensils/cookware for their intended purpose. Follow manufacturer's instructions. Some utensils/cookware were not made to be used in the oven or on the cooking surface.

Safety Before Operating

Cook Meat and Poultry Thoroughly

- Cook meat and poultry thoroughly—meat to at least an INTERNAL temperature of 160°F and poultry to at least an INTERNAL temperature of 180°F.
- To protect against food-borne illness, always cook to the proper temperatures.

Oven

WARNINGS:

- **NEVER** block any slots, holes or passages in the oven bottom or cover an entire rack with materials such as aluminum foil. Doing so blocks air flow through the oven and may cause carbon monoxide poisoning. Aluminum foil linings may also trap heat, causing a fire hazard.
 - When opening the door of a hot oven, stand away from the range. The hot air and steam that escape can cause burns to hands, face and eyes.
- **DO NOT** heat closed food containers. Pressure could increase and the container could burst, causing an injury.
 - **DO NOT** use aluminum foil anywhere in the oven except as described in this manual. Doing so could create a fire hazard or cause damage to the range.
 - **DO NOT** use the oven for a storage area. Items stored in the oven can catch on fire.
 - Keep the oven free from grease buildup.
 - Only insert/replace the oven racks when the oven is cool.
 - When removing food, slide racks out until the stop engages, then remove food items to prevent burns caused by touching the hot surfaces of the door or oven walls.
 - When using cooking or roasting bags in the oven, follow the manufacturer's directions.
 - Use only glass cookware that is recommended for use in gas ovens.
 - Always remove the broiler pan from the range after you finish broiling. Grease left in the pan can catch fire if oven is used without removing the grease from the broiler pan.
 - When broiling meat, trim excess fat as it may ignite when it is too close to the flame.
 - Make sure the broiler pan is in place correctly to minimize the possibility of grease fires.

- If you should have a grease fire in the broiler pan, turn the Cooking and Temperature knobs to the OFF positions and keep the oven door closed to contain fire until it burns out.
- For safety and better cooking performance, always bake and broil with the oven door closed. **WARNING: NEVER** block any slots, holes or passages in the oven bottom or cover an entire rack with materials such as aluminum foil. Doing so blocks air flow through the oven and may cause carbon monoxide poisoning. Aluminum foil linings may also trap heat, causing a fire hazard. **NOTE:** Open door baking or broiling can cause damage to the knobs or valves. **DO NOT LEAVE THE OVEN DOOR OPEN DURING COOKING OR COOL DOWN.**

**READ AND FOLLOW THIS
SAFETY INFORMATION
CAREFULLY.**

**SAVE THESE
INSTRUCTIONS!**

Operation

Location of Controls

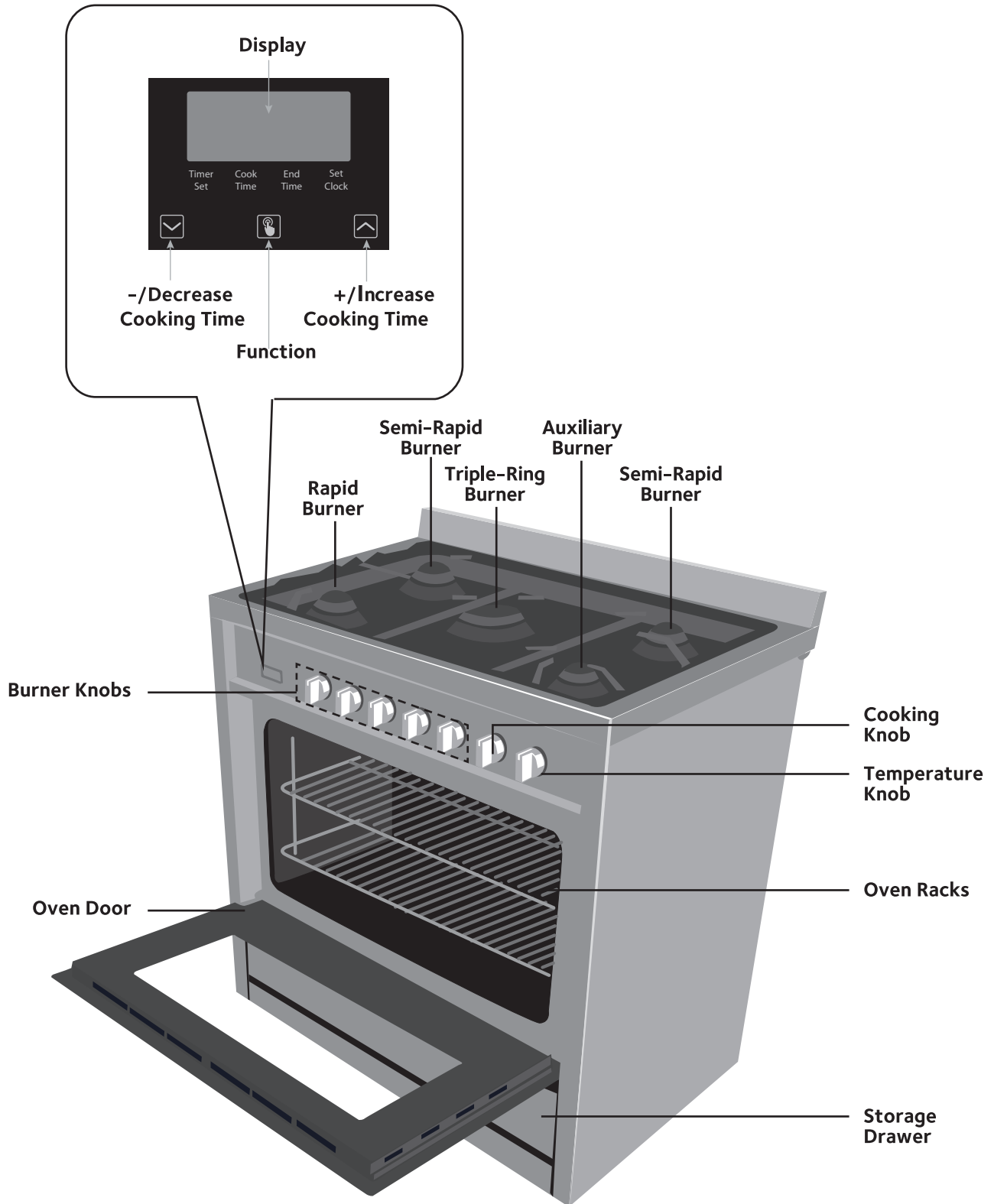

Operation

Setting the Clock

1 When first connected to AC power or after a power outage, the display will blink “12:00” and the Clock indicator will blink. You can enter the Time Setting mode manually by pressing and releasing the Function button until the Clock indicator blinks.



2 To set the correct time, press the ▲ or ▼ button to advance forward or backward until the correct time is displayed. When finished, press the Function button, or wait five seconds; the time will then be set.



IMPORTANT: Clock must be set in order for the oven functions to work.

Setting the Timer

1 Enter the Time Setting mode by pressing the Function button once; the Timer indicator will light.



2 Set the desired timer time using the ▲ or ▼ button to advance forward or backward until the desired time is displayed. The timer will count down and beep when it is finished.



WARNING:



- Use caution with the timed cooking. Use only when cooking cured or frozen meats or most fruits and vegetables. Timer function should be used with caution when cooking foods that can easily spoil, such as milk, eggs, fish, meat or poultry. Eating spoiled food can result in sickness from food poisoning.

Oven Timed Cooking

Delayed Start Timing

To start cooking time, set the TIMER to desired amount of time BEFORE setting oven function and temperature.

1 Press and release the Function button until the Start indicator blinks.

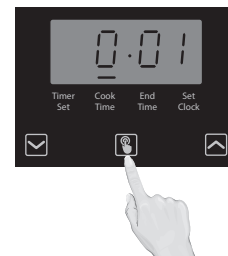

2 Set the amount of time desired by pressing the ▲ or ▼ button until the chosen timing is displayed, for a maximum of 10 hours.



3 Set the Temperature and Cooking knobs as desired (see pages 30 to 32 for descriptions and operation) and place the food in the oven.

Note: Oven will not operate until the programmed Start Time is reached. To operate oven before the Start Time, the Delay Start function must be cancelled.

Programing the End Timing

To end cooking time, set the TIMER to desired shut off time:

1 Press the Function button again until the End indicator blinks.



2 Set the end timing by pressing the ▲ or ▼ button until the desired amount of time is displayed, for a maximum of 11 hours 59 minutes. Press the Function button again to set.



3 When the end of timed cooking is reached, the unit will beep. Rotate the Temperature and Cooking knobs to their OFF positions, and then press the Function button to turn off the beeping.

Operation

Burners and Cookware

- 1** Each burner has a different BTU; chose the appropriate burner(s) for best result.

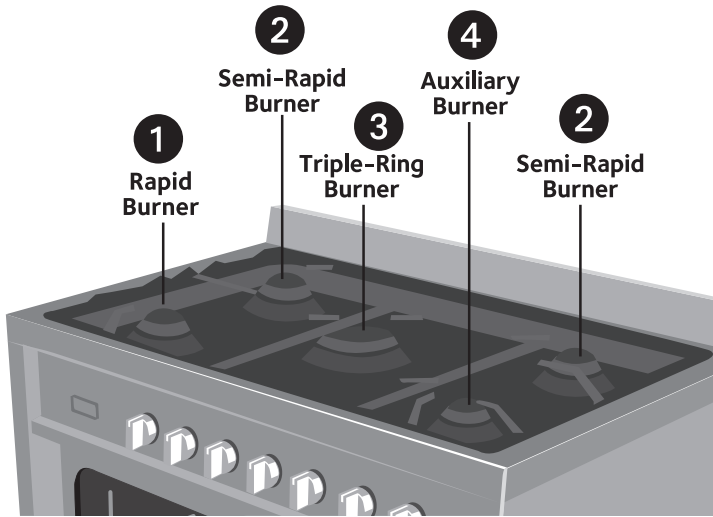

1. Rapid burner and 2. Semi-rapid burners: Primary burners for most cooking - Rapid burner has a slightly higher BTU.

3. Triple-ring burner: Maximum output burner designed to quickly bring large amounts of liquid to a boil or for higher heat level cooking requirements.

4. Auxiliary burner: The lowest BTU burner for precise cooking performance for foods that require low heat at longer cooking times.

- 2** For lower gas consumption and better efficiency: Use only flat-bottomed cookware. Check for flatness by rotating a ruler across the bottom of the cookware; there should be no gaps between the pan and ruler.

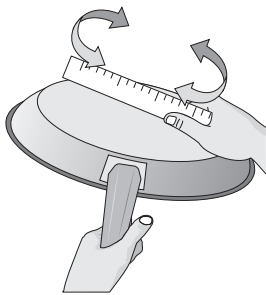

Use cookware with dimensions suitable for each burner. (See Table Figure 33)

As soon as a liquid comes to a boil, turn the flame down to a level that will keep it at a simmer.

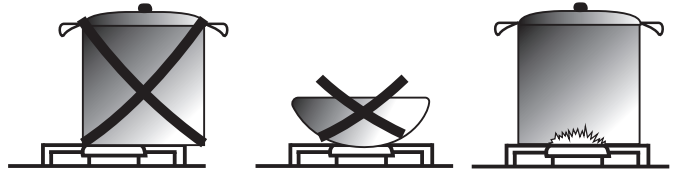

- 3** To avoid potential hazards and prevent uneven cooking it is important to place cookware directly on the burner (See above illustration).

Using the appropriate cookware will also help reduce cooking times and cook food more evenly (See Chart Figure 34)

CORRECT	INCORRECT
<p>Flat bottom and straight sides.</p> <ul style="list-style-type: none"> • Tight fitting lids. • Weight of handle does not tilt pan. • Pan is well balanced. • Pan size matches the amount of food to be prepared and the size of the surface element. • Made of a material that conducts heat well. • Always match pot diameter to element surface diameter. 	<p>Curved and warped pan bottoms.</p> <p>Pan overhangs element by more than 1/2 inch.</p> <p>Pan is smaller than element.</p> <p>Heavy handle tilts pan.</p>

Figure 34

TRIPLE PAN SUPPORT:

The Triple Pan Support (included) is used to stabilize larger pots or to support food simmer. It can be used with all burners although it is most commonly used for the triple burner.

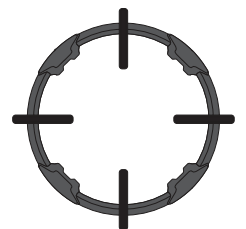

Figure 33

BURNER	MINIMUM DIAMETER OF PAN	MAXIMUM DIAMETER OF PAN
Rapid (front left)	178 mm (7 inches)	254 mm (10 inches)
Semi-Rapid (rear left and right)	152 mm (6 inches)	203 mm (8 inches)
Auxiliary (front right)	76 mm (3 inches)	178 mm (7 inches)
Triple-Ring (center)	203 mm (8 inches)	330 mm (13 inches)

Operation

Burner Cooking

- 1 Igniting the burner:** Push in and rotate the desired Burner knob to the Ignite (★) position (clicking sound will be heard). Continue pressing the Burner knob (5 to 10 seconds). This is necessary to heat up the thermocouple and activate the safety valve, which would otherwise cut off the gas flow.

If the burner fails to ignite, wait one minute for the gas to dissipate before attempting to reignite.

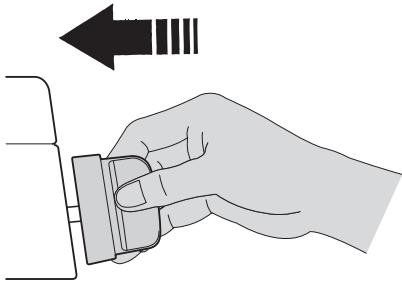

- 2 Adjusting the flame** Rotate the Burner knob counter-clockwise to the desired position (See Page 36).

Flames should not extend up the sides of the cookware. Flames extending beyond the bottom of the cookware will not speed up cooking time and could be hazardous.

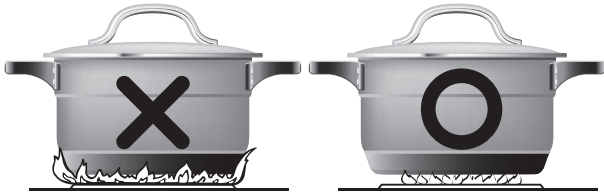

- 3 Turning the flame off:** Push in and rotate the desired Burner to the OFF position. Always turn the flame off before removing cookware from the burners.

In case of a power failure, place a lit match near the burner and follow Step 1. If the burner does not light after a few attempts, check that the burner cap and burner ring are correctly positioned. (See Page 22)

Oven Racks

Placing the Oven Racks: The oven has four rack positions for various types of cooking.

To install an oven rack, insert the rack into the guides on the oven wall. Tilt the front of the rack upward and slide into place.

To remove an oven rack, pull the rack forward until it stops. Tilt the front of the track upward and pull out.

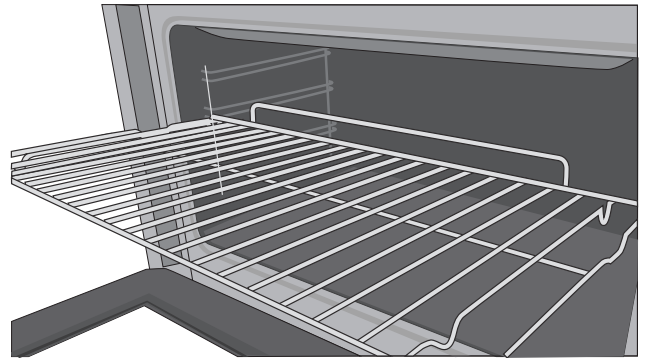

WARNINGS:



ALWAYS ARRANGE OVEN RACKS WHEN THE OVEN IS COOL

- Always use potholders or oven mitts when removing food or adjusting the oven racks.
- Oven racks may be **HOT** and may cause burns.
- **NEVER** cover the oven walls or bottom with aluminum foil. Aluminum foil will melt to the interior surface of the oven and cause permanent damage to the oven.
- **DO NOT** cover racks with aluminum foil as this will affect heat distribution and produce poor baking results.

Operation

Oven Controls

- 1 Rotate the Cooking knob to select the desired Cooking Mode.

The Cooking Indicator will light when activated and turn off when desired temperature is reached.



- 2 After selecting the desired Cooking Mode (See following section), rotate the Temperature knob to the desired temperature.

The Temperature indicator light will turn on while preheating and will turn off when fully preheated.

The Temperature indicator may flicker on and off while the oven maintains the desired temperature.

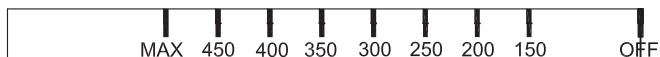

- 3 **Preheating:** Wait until the oven reaches its set temperature before placing the food in the oven. Preheating is necessary for satisfactory results when baking cakes, cookies, pastries and breads.

For best baking results, pans should be centered on the racks. If baking with more than one pan, place the pans so that each one has at least 1" to 1-1/2" of air space around them.

- 4 When cooking is completed, rotate both knobs to their OFF positions.

Oven Cooking Modes

Light

Rotate the Cooking Knob to this position to turn on the oven light. Heat will not be produced by the oven while the oven light is turned on.

Bake (TRADITIONAL COOKING)

(Upper and lower elements and Fan) 140° F TO MAX:

Heat is produced from the top and bottom elements. The oven must be preheated before the food is placed inside the oven.

Traditional Cooking mode provides optimum results with cakes, pizzas, bread and for foods such as casseroles.

For best results, when using this mode, place the food on the second or third rack (as shown below).

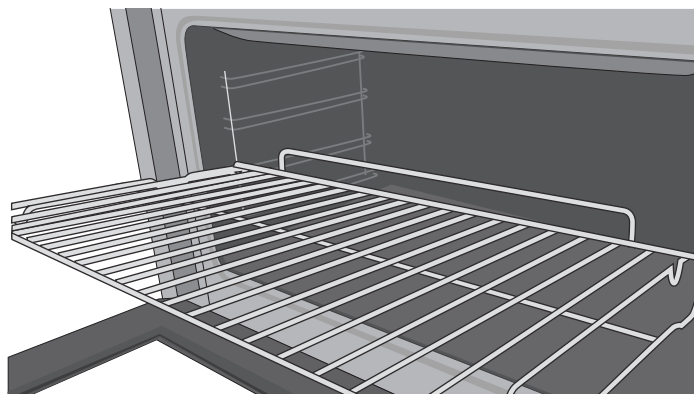

Pizza (DELICATE COOKING)

(Lower element and Fan) 140° F TO MAX:

Heat is produced from the bottom element and the convection fan.

The Delicate Cooking mode is ideal for moist pastries, cakes and dessert molds.

For best results, when using this mode, place the food on the bottom rack (as shown below).

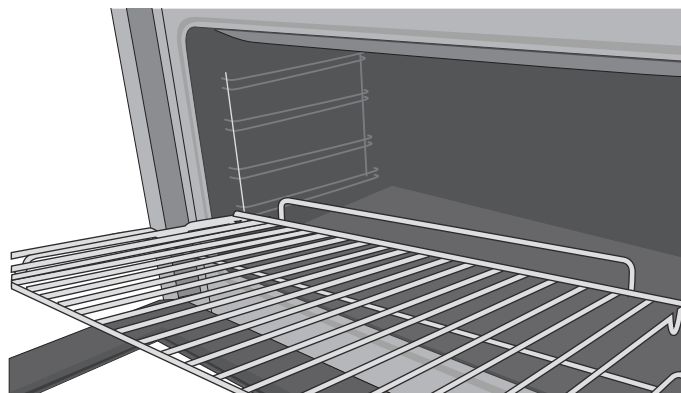

Operation

Oven Cooking (Continued)

Low Broil (BROWNING)

(Upper element and fan) 140° F TO MAX:

Heat is produced from the upper element and the convection fan.

The Browning mode best used to gently brown dishes at the end of the cooking time period.

For best results, when using this mode, place the food on the top or second rack (as shown below.)

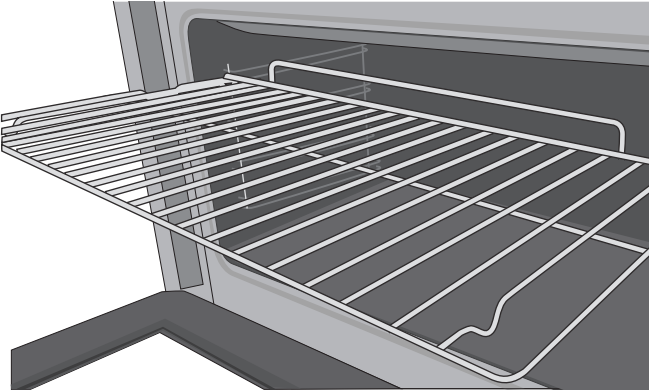

High Broil (BROIL COOKING)

(Grill element) 140° F TO MAX:

Heat is produced from the grill element.

The Broil Cooking mode is best reserved for melting cheese, toasting and browning. The Broil Cooking time should not be any longer than 5 minutes.

For best results, when using this mode place item on the top or second rack (as shown below.)

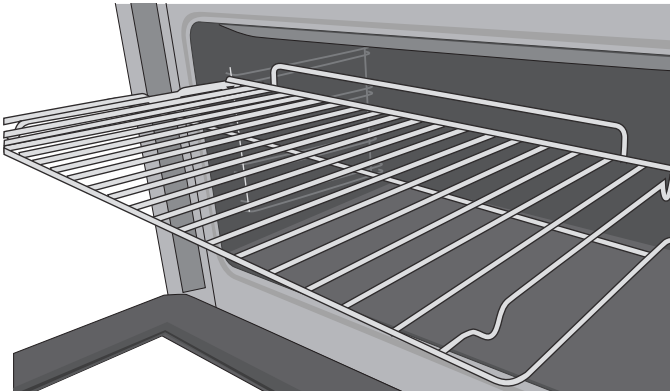

Conv Broil (FAN ASSISTED GRILL COOKING)

(Grill element and Fan) 140° F TO 392° F:

Heat is produced from the grill element and the convection fan.

The Fan Assisted Grill Cooking mode is best used for grilling meats, vegetables and poultry.

For best results, preheat the oven and place the food on the second or third rack of the oven (as shown below).

Other racks may be used simultaneously using this mode.

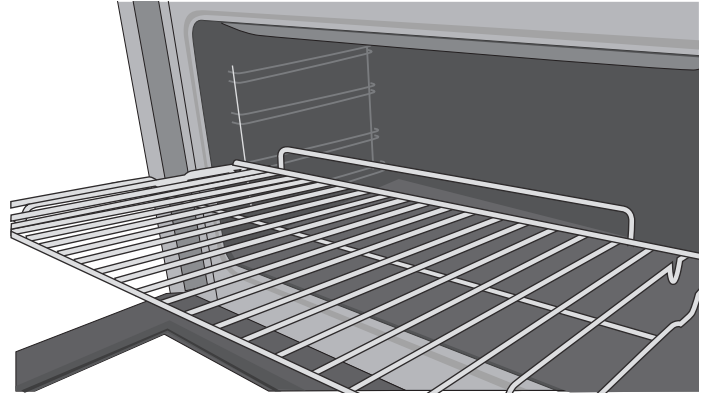

Conv Bake (CONVECTION COOKING)

(Cooking element and Fan) 140° F TO MAX:

Convection Cooking mode permits even-heat multi-rack cooking for various types of foods with the appropriate cooking times for each dish.

The oven must be preheated before the foods are placed inside.

When baking cookies or biscuits, you should use pans with very low sides to allow the heated air to circulate around the food.

Using a pan with a dark finish will allow faster cooking times.

Defrost

(Bottom fan) 140° F TO MAX:

Defrost mode permits all types of frozen food to be defrosted by circulating room temperature air around the food.

For foods such as meat, fish and bread, set the Temperature knob to 350-400° F.

Operation

Cooking Chart

Setting:	Food:	Rack Level See page 31	Temperature (Fahrenheit):	Time (mins):
Traditional Cooking (add time for preheating)	Lasagna	2-3	410-450	30
	Oven-Baked Pasta	2-3	410-450	40
	Roast Veal	2	350-400	30-40/lb
	Beef	2	410-460	30-40/lb
	Pork	2	340-400	30-40/lb
	Chicken	2	340-400	45-60
	Duck	2	340-400	45-60
	Goose/Turkey	1	280-340	45-60
	Lamb	2	340-400	15/lb
	Fish	1-2	340-400	Depends on depth on food
	Pizza	1-2	410-450	40-45
	Short Pastry	1-2	340-400	15-20
	Fruit Cake	1-2	340-400	20-30
	Browning	3-4	140	5
Convection Cooking (add time for preheat)	Lasagna	2-3	375-410	20-25
	Oven-Baked Pasta	2	375-410	25-30
	Roast Veal	2	300-350	65-90
	Beef	2	350-375	65-90
	Pork	2	300-325	70-100
	Chicken	2	350	70-90
	Duck	2	325-350	100-160
	Goose/Turkey	2	300-325	160-240
	Lamb	2	300-350	100-130
	Fish	2-3	300-350	Depends on depth on food
	Pizza	2-3	410-475	30-50
	Sponge Cake	2-3	375-425	25-35
	Fruit Cake	2-3	350-375	40-50
	Bread	1-2	425-475	7
Setting:	Food:	Rack Level See page 31	1 st Side Cook Time (mins):	2 nd Side Cook Time (mins):
Grill Cooking	Pork Chops	4	7-9	5-7
	Fillet (Pork)	3	9-11	5-9
	Fillet (Beef)	3	9-11	9-11
	Liver	4	2-3	2-3
	Veal	4	7-9	5-7
	Chicken	3	9-14	9-11
	Sausages	4	7-9	5-6
	Meatballs	4	7-9	5-6
	Fish Fillet	4	5-6	3-4
	Toast	4	2-4	2-3

Care and Maintenance



WARNINGS:

- Please make sure to read ALL safety precautions on pages 4 to 10 and 25 to 27.
- **Electric Shock Hazard.**
- To avoid possible burns use care when cleaning the appliance.
 - DO NOT attempt to clean the appliance whenever the oven or burner rings are still hot.
 - DO NOT attempt any of the following cleaning instructions before turning all burners and the oven off, and allow them to completely cool.**IMPORTANT:** Always follow label instructions on cleaning products.

Control Knobs

To clean, use a damp soapy cloth for everyday cleaning of the knobs. For heavier cleaning for grease, etc., apply a non-abrasive liquid detergent to a damp cloth. Clean and then dry completely.

Make sure not to rotate the knobs when cleaning.

Burner Grates

These three grates should only be used in their proper positions. DO NOT operate a burner for an extended period of time without cookware on the grate. To clean, AFTER COOLING, use hot water or white vinegar, and DO NOT place in a dishwasher. When replacing the grates, be sure they are positioned securely over the burners.

Please note that the grates have rubber pads on the feet that come into contact with the range to avoid scratches. After cleaning it is important to verify that these rubber pads are still there. Should they come off, they can be reapplied using a heat-resistant adhesive.

Burner Rings

Lift off when cool. Wash burner rings in hot, soapy water and rinse with clean water. To remove burned-on food particles, you may scour with a **plastic** scouring pad. Thoroughly dry before returning the rings to the range.

The rings are NOT dishwasher safe.

Do not use cleaners for stainless steel surfaces as these rings are not stainless steel.

Oven Door Exterior

To clean, apply the glass cleaner onto a sponge and clean. Do not spray cleaner directly onto the door.

Burner Caps

Lift off when cool. Wash Burner Caps in hot, soapy water and rinse with clean water. Remove any food from between the burner slots using a small non-abrasive brush like a toothbrush, and afterwards wipe using a damp cloth.

To remove deposits from the burner cavities, remove the cap and separate the two parts. Clean the burner holes routinely with a small gauge wire or needle and especially after bad spills which could clog these holes.

Thoroughly dry before returning the heads to the range.

The heads are NOT dishwasher safe.

Stainless Steel

To clean the stainless steel surface, use warm sudsy water or a stainless steel cleaner or polish. Always wipe the surface in the direction of the grain. Follow the cleaner instructions for cleaning the stainless steel surface.

DO NOT use a steel wool pad as it will scratch the surface. Do not use cleaners with high concentrations of chlorides or chlorines. Do not use harsh scrubbing cleaners.

Oven Cavity

This appliance does NOT have a self-cleaning feature.

Use an appropriate cleaning product designed specifically to clean the inside of ovens. **IMPORTANT:** Always follow label instructions on cleaning products.

Storage Drawer

Make sure the drawer is closed and then empty it completely. Use a mild detergent to clean.

Care and Maintenance

Removing the Oven Door

WARNINGS: 

- The oven door is removable, but it is heavy. You may need help removing and replacing the door.
- Be careful when removing and lifting the door.
- DO NOT lift the door by the handle.

For normal range use it is not suggested to remove the oven door. However, if removal is necessary, make sure the oven is off and cool. The oven door is heavy. Follow these instructions.

- 1** Open the door fully.



- 2** Lift up and push the small levers located on the two hinges all the way back to unlock.



- 3** While holding the door on each side, shut the door until it touches the levers. Continue closing the door until it is about 4" (10 cm) from being fully closed.

- 4** Pull the door towards you, pulling it out of its seat. The door will gently come away from the oven. If door does not come away from oven easily, do not force it.

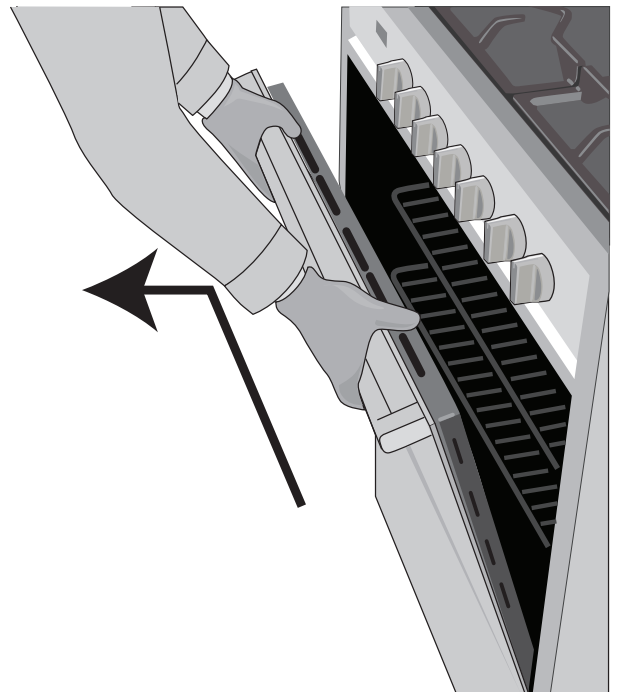

- 5** To replace the door, perform the previous steps in reverse order.

Care and Maintenance

Replacing the Light Bulb

WARNINGS:



- Before replacing your oven light bulb, DISCONNECT the electrical power to the range at the main fuse or circuit breaker panel.
- Make sure oven and bulb are cooled completely.

- 1 Remove the glass cover by turning counter-clockwise.

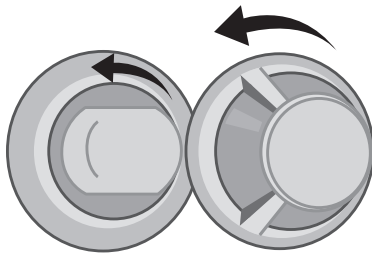

- 2 Remove the bulb by turning it counter-clockwise.

- 3 Replace the bulb with a 240V, 25W type e-14 bulb. Reconnect power.

Adjusting the Burner Flames

- 1 Turn all burners to their highest settings and check the flames. They should be blue in color and may have some yellow tipping at the ends of the flame when using LP gas. Foreign particles in the gas line may cause an orange flame at first, but this will soon disappear.

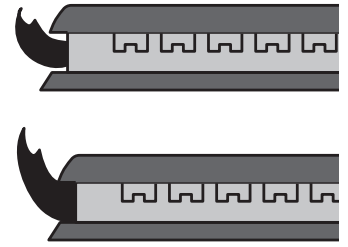

A. Low flame
B. High flame

- 2 Turn the desired burner knob to Low (🔹) and observe the flame.
- 3 Set two other burners to Medium. This will prevent the upper row of flames from being set too low, resulting in the flame being extinguished when other burners are turned on.
- 4 To adjust the flame, remove the knobs; insert the included 3/32 screwdriver through the access hole to engage the brass slotted screw as shown. Make the adjustment by slowly turning the screw until the flame appearance is correct.

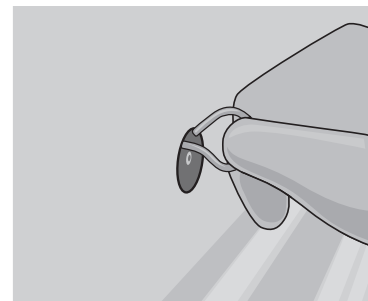

Test 1: Turn the burner knob from High (🔸) to Low (🔹) quickly. If the flame goes out, increase the flame size and test again.

Test 2: With the burner knob on a Low (🔹) setting, open and close the oven door quickly. If the flame is extinguished by the air currents created by the door movement, increase the flame height and test again. If the flames are too small or fluttered, open the valve more than the original setting. If the flames are too large, close the valve more than the original setting.

Before Calling for Service

Before calling for service, review this list. It may save you both time and expense. This list includes common experiences that are not the result of defective workmanship or materials in your appliance.

NOTHING WILL OPERATE

- **Is the electrical supply disconnected?**
Verify that electrical wires are connected to the mains properly. See “Connect to AC” section. If the problem continues, contact a qualified technician.
- **Is the household fuse blown or circuit breaker tripped?**
Replace the fuse or reset the circuit breaker. If the problem continues, contact a qualified technician.
- **Is the main or regulator gas shut-off valve in the off position?**
See “Gas Connection” section and rotate to the On position.
- **Is the range properly connected to the gas supply?**
Contact a qualified technician. See “Gas Connection” section.

SURFACE BURNERS WILL NOT LIGHT

- **Is this the first time the surface burners have been used?**
Turn on any one of the surface burner knobs to release air from the gas lines.
- **Did you push in on the knob before turning?**
The knobs require that they are pushed in before rotation to prevent accidental turning.
- **Are the burner ports clogged?**
Clean the burner rings and caps as stated in the “Care and Maintenance” section.

SURFACE BURNERS ARE UNEVEN, YELLOW AND/OR NOISY

- **Are the burner ports clogged?**
Clean the burner rings and caps as stated in the “Care and Maintenance” section.
- **Are the burner caps positioned properly?**
See “Burner Rings and Caps Replacement” section.
- **Is propane gas being used?**
The range may have been converted improperly. Contact a qualified service technician. See “Liquefied Petroleum (Propane) Gas Conversion” section.

SURFACE BURNER MAKES POPPING NOISES

- **Is the burner wet?**
Burners cannot operate or light if wet, so let completely dry.

OVEN MAKES POPPING NOISES

- **This is normal**
This is the sound of the metal heating and cooling during both the cooking and Off functions, and is normal.

EXCESS HEAT AROUND COOKWARE ON COOKING SURFACE

- **Is the cookware the proper size?**
Use cookware about the same size as the surface cooking area, element or surface burner. Cookware should not extend more than 1/2” (1.3 cm) outside the cooking area.

COOKING RESULTS NOT WHAT EXPECTED

- **Is the proper cookware being used?**
Use the proper cookware as shown on page 29.
- **Is the Temperature knob set to the proper heat level?**
Push in and rotate the Temperature knob to the desired setting and let the oven preheat until it reaches the temperature before you begin cooking.
- **Is the Cooking knob set to the proper setting?**
Push in and rotate the Cooking knob to the desired setting; see pages 31 to 32 for description of icons.
- **Is the range level?**
Level the range as shown on page 15.

OVEN WILL NOT OPERATE

- **Are the oven controls set correctly?**
See pages 30 to 32 to make sure the knobs are set as intended.
- **Is the Oven Timer set?**
Oven will not operate when the Oven Timer is set; see page 28.

COOLING FAN RUNS DURING BAKING AND BROILING

- It is normal for the fan to automatically run while the oven is in use and for some time after during cooling.

Before Calling for Service

OVEN TEMPERATURE TOO HIGH OR TOO LOW

- **Was the oven preheated?**
Push in and rotate the Temperature knob to the desired setting and let the oven preheat until it reaches the temperature before you begin cooking.
- **Are the racks positioned properly?**
See pages 31 to 32 for rack positioning.
- **Is there proper air circulation around bakeware?**
If bakeware takes up too much room, air circulation will be reduced.
- **Is the batter evenly distributed in the pan?**
Check that batter is level in the pan when baking.
- **Is the proper length of time being used?**
Make sure proper cooking time was used.
- **Has the oven door been opened while cooking?**
Oven “peeking” releases oven heat and can result in longer cooking times.
- **Are baked items too brown on the bottom?**
Move rack to higher position in the oven.
- **Are pie crust edges browning early?**
Use aluminum foil to cover the edge of the crust and/or reduce baking temperature.

NO SPARK WHEN LIGHTING BURNER

- **Electrical supply - The electrical wires or the plug are not connected properly.**
Connect with electrical power again. If the problem continues, contact a qualified technician.
- **Burner - The burner is not installed correctly.**
Install the burner again. See “Burner Rings and Caps Replacement” section.
- **Spark pin - Ignition electrode and the hole are not inserted properly.**
Install the burner again. See “Burner Rings and Caps Replacement” section.

THE FLAME GOES OUT ONCE RELEASING THE KNOB

- **Safety valve - Knob not pressed down long enough.**
Press and turn the knob again and hold down three to five seconds after the burner has been lit. This is a safety feature.

BURNER WON'T IGNITE OR BURNS UNEVENLY

- **Gas valve - The valve is not open.**
Make sure the valve is completely open.
- **Gas pipe - There may be air in the gas pipe.**
Ignite repeatedly until flame catches to release the air from the pipe.
- **Burner cap issues.**
The burner cap is not placed correctly; replace the burner cap. Some holes in the lid are blocked; clean the holes of the lid.
- **Spark pin - The spark pin is wet or contaminated by the food.**
Clean and dry the spark pin.
- **Gas connecting pipes - The gas connecting pipes are blocked or pinched.**
Contact a qualified technician. Adjust or change the connecting pipes.

STRANGE SMELL

- **Gas leak - Turn off the gas and contact a qualified technician.**
- **The gas supply pipe is old and/or broken. Change the gas supply pipe.**

Please register your product warranty by visiting the Ancona Home website.



Canada & USA

Phone: 1-888-686-0778

Fax: 800-350-8563

Email: service@anconahome.com

Website: www.anconahome.com

Ancona is in association with Mr Appliance for all after sales service calls.
Please contact their service provider or visit their website:

Phone: 888-686-0778

Website: www.mrappliance.com



MAAN2221-01