



**COOKTOP
USER MANUAL
&
INSTALLATION INSTRUCTIONS**

**ANCONA ELITE
30" & 34" GAS COOKTOPS**

IMPORTANT SAFETY INSTRUCTIONS

**Carefully read the following important information regarding
installation safety and maintenance.**

Keep these instructions for future reference.

Table of Contents

| | |
|---|----|
| Table of Contents..... | 2 |
| Safety | 3 |
| Parts Supplied | 8 |
| Getting Started | 8 |
| Grounding Instructions..... | 9 |
| Liquefied Petroleum (Propane) Gas Conversion | 10 |
| Surface Cooking | 10 |
| Flame Size..... | 10 |
| Proper Burner Adjustments | 11 |
| Location of the Burners | 11 |
| Placement of Burner Heads and Caps | 12 |
| Surface Cooking Utensils..... | 12 |
| Setting Surface Controls | 13 |
| To Operate the Surface Burners | 13 |
| Knob Symbols..... | 14 |
| Lighting the Burners..... | 14 |
| Care and Cleaning..... | 15 |
| Solutions to Common Problems..... | 16 |
| Installation Instructions | 17 |
| Advance Preparation | 18 |
| Provide an Adequate Gas and Electrical Supply | 19 |
| Tools and Materials Needed | 19 |
| Cutting the Countertop..... | 20 |
| Installing the Pressure Regulator | 22 |
| Electrical Connection | 25 |
| Assembling the Burners..... | 25 |
| LP/Propane Gas Conversion | 27 |

Safety





IMPORTANT SAFETY NOTICE





READ ALL INSTRUCTION BEFORE INSTALLING AND OPERATING THIS APPLIANCE







-  Remove all tape and packaging before using the cooktop. Never allow children to play with packaging material. Do not remove the model/serial plate attached to the cooktop.

-  Be sure your appliance is properly installed and grounded by a QUALIFIED TECHNICIAN in accordance with the National Fuel Gas Code ANSI Z223.1—latest edition in the United States, or in Canada CAN/CGA B149.1, and CAN/CGA B149.2, and the National Electrical Code ANSI/NFPA No. 70—latest edition in United States, or in Canada CSA Standard C22.1, Canadian Electrical Code, Part 1, and local code requirements. Install only as per installation instructions provided in the literature package for this cooktop.

-  If the information in this manual is not followed exactly, a fire or explosion may result causing property damage, personal injury or death.

-  **FOR YOUR SAFETY:**
 - Do not store or use gasoline or other flammable vapors and liquids in the vicinity of this or any other appliance.

-  **WHAT TO DO IF YOU SMELL GAS:**
 - Do not try to light any appliance.
 - Do not touch any electrical switch; do not use any phone in your building.
 - Immediately call your gas supplier from a neighbor's phone. Follow the gas supplier's instructions.
 - If you cannot reach your gas supplier, call the fire department.

-  Installation and service must be performed by a qualified installer, servicer or the gas supplier. Ask your dealer to recommend a qualified technician and an authorized repair service. Know how to shut off gas supply at the meter and disconnect the electrical power to the cooktop at the circuit breaker or fuse box in case of an emergency.
-  Do not repair or replace any part of the appliance unless specifically recommended in the manuals. All other servicing should be done only by a qualified technician. This may reduce the risk of personal injury and damage to the cooktop.
-  Never modify or alter the construction of a cooktop by removing panels, wire covers or any other part of the product.
-  Overhead range hoods, which operate by blowing a downward air flow on to a range, shall not be used in conjunction with gas ranges other than when the hood and range have been designed, tested and listed by an independent test laboratory for use in combination with each other.
-  Ensure that the room is well ventilated by keeping the air intakes open and in good working order or by installing an extractor hood with discharge pipe. If the appliance is used intensively for a long time the effectiveness of the ventilation will have to be increased, for example by opening a window or increasing the power of any electric extractor fan.
-  Flammable materials should not be stored on the cooktop or near surface units. This includes paper, plastic and cloth items, such as cookbooks, plastic ware and towels, as well as flammable liquids. Do not store explosives, such as aerosol cans, on or near the cooktop. Flammable materials may explode and result in fire or property damage.
-  Do not store items of interest to children in the cabinets above the cooktop. Children should not be left alone or unattended in the area where appliance is in use. Do not allow children to climb or play around the cooktop. They should never be allowed to sit or stand on any part of the appliance. Children climbing on the cooktop to reach items could be seriously injured.

-  DO NOT TOUCH THE COOKTOP SURFACE, THE BURNERS, GRATES OR ANY AREAS NEAR THEM. Surface burners or cooktop may be hot even though flames are not visible. Areas near surface burners or cooktop may become hot enough to cause burns. During and after use, do not touch, or let clothing or other flammable materials touch these areas until they have had sufficient time to cool. Among these areas are the cooktop and surfaces facing the cooktop.

-  Do not wear loose-fitting or hanging garments while using the appliance. Do not let clothing or other flammable materials contact hot surfaces.

-  Smother grease fires with a pan lid, or use baking soda, a dry chemical or foam-type extinguisher.









-  Use an extinguisher ONLY if:
 - You know you have a Class A, B, C extinguisher, and you already know how to operate it.
 - The fire is small and contained in the area where it is started.
 - The fire department is being called.
 - You can fight the fire with your back to an exit.



-  When heating fat or grease, watch it closely. Fat or grease may catch fire if allowed to become too hot.

-  Use only dry potholders. Moist or damp potholders on hot surfaces may result in burns from steam. Do not let potholders touch hot heating elements, the flame or burners. Do not use a towel or other bulky cloth instead of a potholder.

-  Do not heat unopened food containers. Buildup of pressure may cause the container to burst and result in injury.

-  Stepping, leaning or sitting on this cooktop can result in serious injuries and also cause damage to the cooktop.

-  Never use this appliance as a space heater to heat or warm the room. Doing so may result in carbon monoxide poisoning and overheating of the oven.
-  Know which knob controls which surface burner. Visually check that the burner has lit. Then adjust the flame so it does not extend beyond the edge of the utensil.
-  Clean the appliance regularly to keep all parts free of grease that could catch fire. Exhaust fan ventilation hoods and grease filters should be kept clean. Do not allow grease to accumulate on hood or filter. Greasy deposits in the fan could catch fire. When cooking food turn the hood, fan on. Refer to hood manufacturer's instructions for cleaning.
-  Utensil handles should be turned inward and not extend over adjacent surface burners. To reduce the risk of burns, ignition of flammable materials, and spillage due to unintentional contact with the utensil, the handle of the utensil should be positioned so that it is turned inward, and does not extend over adjacent surface burners.
-  Never leave surface burners unattended at high heat settings. Boil overs cause smoking and greasy spillovers that may ignite, or a pan that has boiled dry may melt.
-  Do not use aluminum foil to line any part of the cooktop, use aluminum foil only to cover food during cooking. Improper installation of these liners may result in risk of electric shock, or fire.
-  Only certain types of glass, glass/ceramic, ceramic, earthenware, or other glazed utensils are suitable for cooktop service without breaking due to the sudden change in temperature. Check the manufacturer's recommendations for cooktop use.
-  Do not use decorative surface burner covers. If a burner is accidentally turned on, the decorative cover will become hot and possibly melt. You will not be able to see that the burner is on. Burns will occur if the hot covers are touched. Damage may also be done to the cooktop or burners because the covers may cause overheating. Air will be blocked from the burner and cause combustion problems.

-  Always use proper flame size. Adjust flame size so it does not extend beyond the edge of the utensil. The use of undersized utensils will expose a portion of the burner flame to direct contact and may result in ignition of clothing. Proper relationship of utensil to flame will also improve efficiency.
-  Use the proper pan sizes. This cooktop is equipped with surface units of different sizes. Select utensils having flat bottoms large enough to cover the surface unit. The use of undersized utensils will expose a portion of the surface heating unit to direct contact and may result in ignition of clothing. Proper relationship of utensil to the surface unit will also improve efficiency.
-  Do not use stove top grills on your gas cooktop. If you use a stove top grill on a sealed gas burner, it will cause incomplete combustion and can result in exposure to carbon monoxide levels above allowable current standards. This can be hazardous to your health.

Parts Supplied

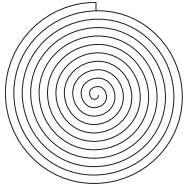

1 x Foam Gasket

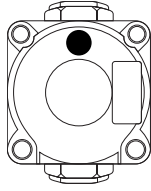

1 x Regulator

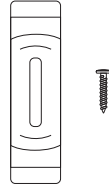

4 x Mounting Clips

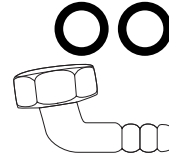

1 x Fitting

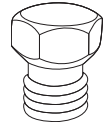

9 x LPG Nozzles

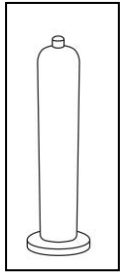

1 x Triple Ring Igniter
1 x Igniter



1 x 3/32" Screwdriver



1 x 7mm Nut Driver



8 x Rubber Grate Supports

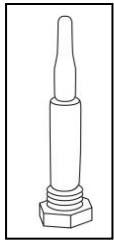

1 x Triple Ring Thermocouple
1 x Thermocouple

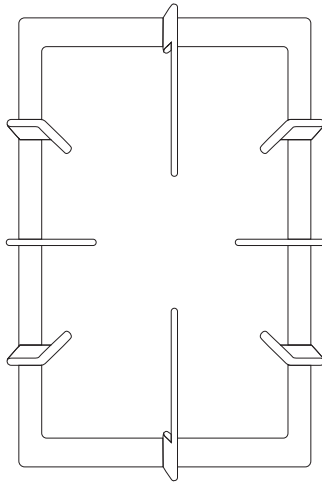

1 x Triple Ring Grate

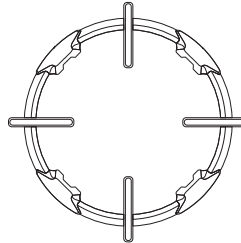

1 x Triple Ring
Pan Support

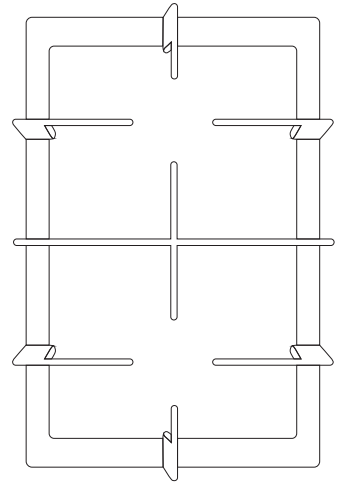

2 x Grates

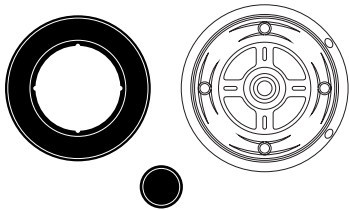

1 x Triple Ring Burner

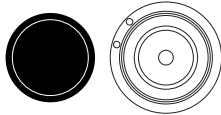

2 x Semi-Rapid Burner

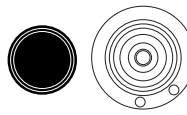

1 x Auxiliary Burner

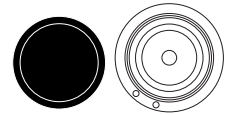

1 x Rapid Burner

Getting Started

Grounding Instructions

- This cooktop features a pilotless electric ignition for energy savings and reliability. It operates on a 120 volt, 60 Hz power supply. A separate circuit, protected by a 15 amp time delay fuse or circuit breaker, is required. For personal safety, the cooktop must be properly grounded. A properly-grounded 3-prong receptacle (see Figure 1) should be located 12" below the countertop and within reach of the cooktop's four-foot power cord. For maximum safety, the power cord must be plugged into an electrical outlet that is correctly polarized and properly grounded.

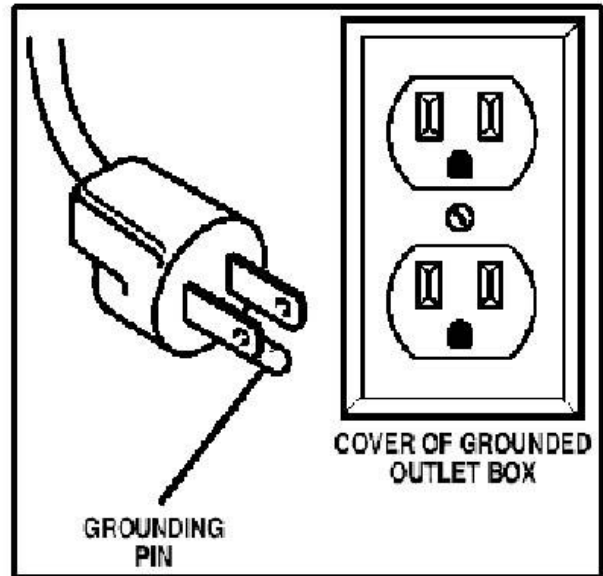



Figure 1

- See the **Installation Instructions** packaged with this cooktop for complete installation and grounding instructions.
- **⚠ DO NOT** operate the cooktop using a 2-prong adapter or an extension cord. If a 2-prong wall receptacle is the only available outlet, it is the personal responsibility of the consumer to have it replaced with a properly grounded 3-prong wall receptacle installed by a qualified electrician.
- This appliance is equipped with a 3-prong grounding plug for your protection against shock hazard and should be plugged directly into a properly grounded receptacle. To avoid fire hazard or electrical shock, **DO NOT** cut or remove the grounding prong from this plug and **DO NOT** use an adapter plug, an extension cord, or remove grounding prong from electrical power cord. Failure to follow this warning can cause serious injury, fire or death.
- **⚠** Severe shock, or damage to the cooktop may occur if the cooktop is not installed by a qualified installer or electrician.

-  Any additions, changes or conversions required in order for this appliance to satisfactorily meet the application needs must be made by a qualified service technician in accordance with the manufacturer's instructions and all codes and requirements of the authority having jurisdiction. Failure to follow the instructions could result in serious injury or property damage. The qualified agency performing this work assumes responsibility for the conversion.

Liquefied Petroleum (Propane) Gas Conversion

- This appliance can be used with Natural Gas and Propane (LP) Gas. It is shipped from the factory for use with natural gas.
- A kit for converting to LP gas is supplied with your cooktop. The kit is marked "FOR LP/ PROPANE GAS CONVERSION". For conversion, follow the installation instructions which are in this manual.
-  The conversion must be performed by a qualified service technician in accordance with the kit instructions and all local codes and requirements. Failure to follow instructions could result in serious injury or property damage. The qualified agency performing this work assumes responsibility for the conversion.

Surface Cooking

Flame Size

- **For most cooking**, start on the highest control setting and then turn to a lower one to complete the process. The size and type of utensil used and the amount of food being cooked will influence the setting needed for cooking.
- **For deep fat frying**, use a thermometer and adjust the surface control knob accordingly. If the fat is too cool, the food will absorb the fat and be greasy. If the fat is too hot, the food will brown so quickly that the center will be undercooked. Do not attempt to deep fry too much food at once as the food will neither brown nor cook properly.

- **⚠** Never extend the flame beyond the outer edge of the utensil (see Figure 2). A higher flame simply wastes heat and energy, and increases your risk of being burned by the flame.

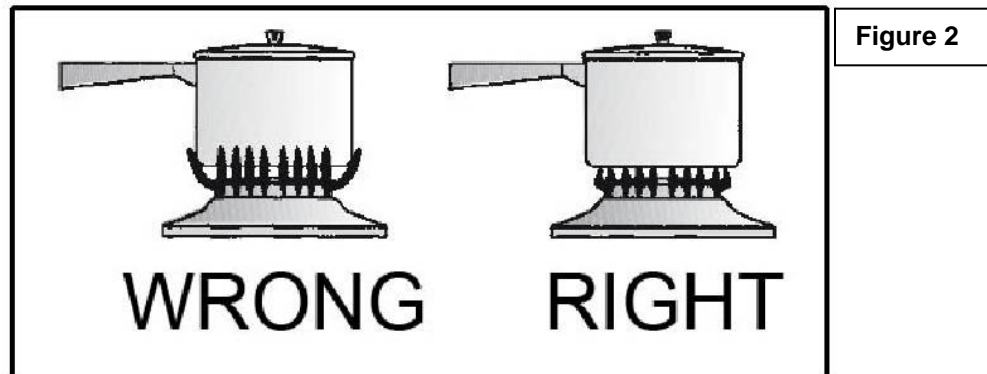

Proper Burner Adjustments

- The color of the flame is the key to proper burner adjustment. A good flame is clear, blue and hardly visible in a well-lighted room. Each cone of flame should be steady and sharply defined. Adjust or clean burner if flame is yellow-orange. To clean burners, see instructions under **Care and Cleaning**.

Location of the Burners

1. Front panel
2. Knob for Triple-ring burner
3. Knob for Semi-rapid burner
4. Knob for Auxiliary burner
5. Knob for Semi-rapid burner
6. Knob for Rapid burner
7. Auxiliary burner - 5,000 BTU
8. Rapid burner – 8,500 BTU
9. Semi-rapid burners – 6,800 BTU
10. Triple-ring burner – 16,000 BTU

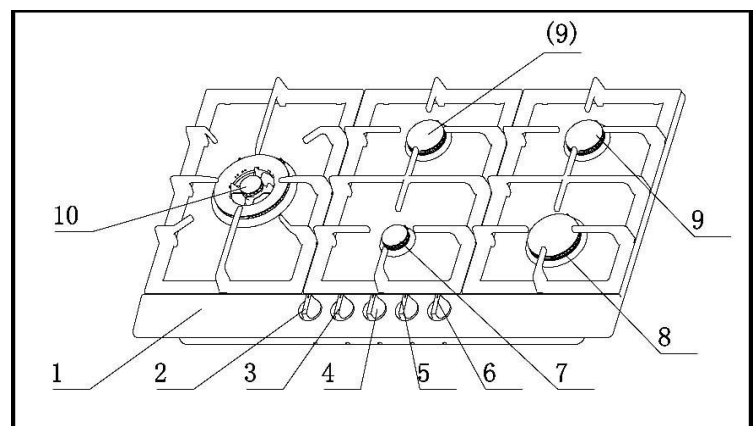

Figure 3

Appearance may vary depending on model purchased.

Placement of Burner Heads and Caps

For all burners:

- Place a burner cap on each burner head (see Figure 4), matching the cap size to the head size. The cap for each burner has an inner locating ring which centers the cap correctly on the burner head. Be sure that all the burner caps and burner heads are correctly placed BEFORE using your appliance.
- Make sure each burner cap is properly aligned and level (see Figure 5).
- **⚠** Turn the burner on to determine if it will light. If the burner does not light, contact a qualified service center. Do not service the sealed burner yourself.

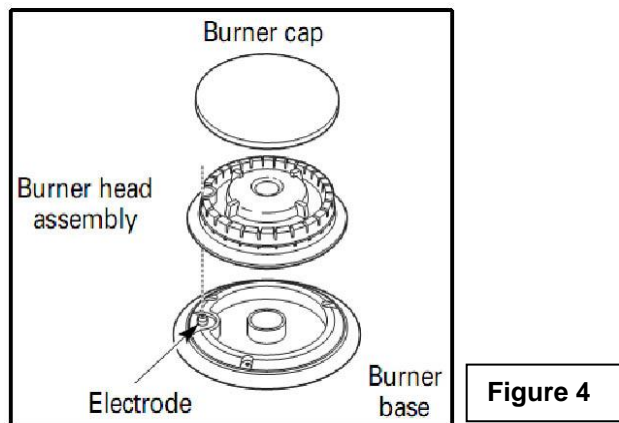

Figure 4

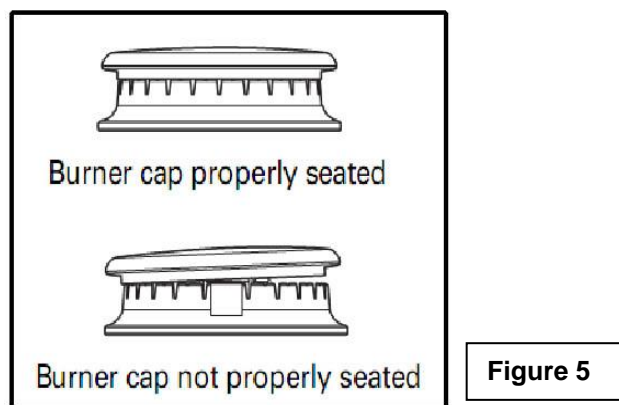

Figure 5

Surface Cooking Utensils

For lower gas consumption and better efficiency: Use only flat-bottomed pans of dimensions suitable for the burners, as shown in the table below. Check for flatness by rotating a ruler across the bottom of the pan. There should be no gaps between the pan and ruler. As soon as a liquid comes to a boil take care to turn the flame down to a level that will just keep it simmering.

Specialty pans (lobster pots and pressure cookers) may be used but must conform to the recommended cookware requirements.

⚠ During cooking processes involving fats or oils, watch your foods carefully because these substances may catch fire if brought to high temperatures.

| Burner | Minimum Diameter of Pan | Maximum Diameter of Pan |
|-------------|-------------------------|-------------------------|
| Rapid | 180 mm (7 inches) | 220 mm (8¾ inches) |
| Semi-rapid | 120 mm (4 ¾ inches) | 200 mm (8 inches) |
| Auxiliary | 100 mm (4 inches) | 160 mm (6 ¼ inches) |
| Triple-ring | 220 mm (8 ¾ inches) | 260 mm (10 ¼ inches) |

⚠ Note: Always use a utensil for its intended purpose. Follow manufacturer's instructions. Some utensils were not made to be used in the oven or on the cooktop.

Setting Surface Controls



Regardless of size, always select a utensil that is suitable for the amount and type of food being prepared. Select a burner and flame size appropriate to the pan. Never allow flames to extend beyond the outer edge of the pan.

⚠ Do not place plastic items such as salt and pepper shakers, spoon holders or plastic wrappings on top of the cooktop when it is in use. These items could melt or ignite. Potholders, towels or wood spoons could catch fire if placed too close to a flame.

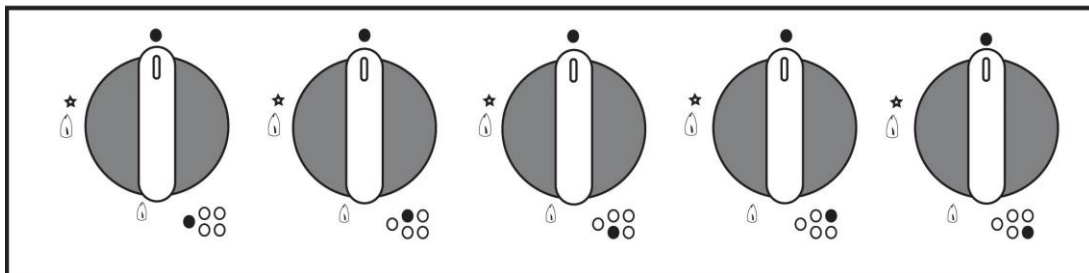
To Operate the Surface Burners





Knob Symbols

| | |
|---|----------------------|
|  | Off - No gas flow |
|  | On –Maximum gas flow |
|  | Minimum gas flow |

Lighting the Burners

- 1) To obtain a flame more easily, light the burner before placing a cooking utensil on the burner grate.
- 2) To light a burner, press the knob of the burner fully down and turn it anti-clockwise to the

“maximum flow” setting symbol:  .

- 3) After lighting the flame, keep the knob pressed down for about 10 seconds. This is necessary to heat up the thermocouple and activate the safety valve, which would otherwise cut off the gas flow.
- 4) Then check that the flame is even and turn the control knob to adjust the flame as required:  .
- 5) In the instance of a power outage, place a lit match near the burner and proceed as already described. If the burner does not light after a few attempts, check that the “burner cap” and “flame cap” are correctly positioned.

⚠ ALWAYS USE CAUTION WHEN LIGHTING BURNERS MANUALLY. ⚠

- 6) To turn off the flame, turn the control knob clockwise to the: ● symbol. Before removing pans from the burners, always lower or turn off the flame.

Care and Cleaning



To avoid possible burns use care when cleaning the cooktop. **DO NOT** attempt to clean the cooktop whenever the cooktop or burner heads are still hot. To avoid possible burns **DO NOT** attempt any of the following cleaning instructions before turning **OFF ALL** of the surface burners and allowing them to cool.

- **Control Knobs** - For general cleaning, use hot, soapy water and a cloth. For more difficult soils and built-up grease, apply a liquid detergent directly onto the soil. Rinse with a damp cloth and dry. **DO NOT** use steel wool or acidic cleaners on the knobs; as they can scratch.
- **Burner Grates** - Clean burner grates in the dishwasher and dry upon removal.
- **Burner Caps** - Should you ever need to remove the burner caps for cleaning lift the burner cap off the burner head. Clean heavy soils with an absorbent cloth. Rinse with a clean, damp cloth and immediately **thoroughly** dry including the bottom and inside of the cap. Do not use harsh abrasive cleaners. They can scratch the cap. Do not clean burner caps in dishwasher.
- **Burner Heads** - The holes in the burners of your cooktop **MUST** be kept clean at all times for proper ignition and a complete, even flame. . Remove any food from between the burner slots using a small nonabrasive brush like a toothbrush and afterwards wipe using a damp cloth. To remove deposits from the burner cavities, remove the cap and separate the two parts. Clean the burner holes routinely with a small gauge wire or needle and especially after bad spillovers which could clog these holes. After cleaning, put the two parts back together and return them correctly to their position, making sure they are seated and level. **DO NOT** put burner units in the dishwasher.
- **Stainless Steel** - Clean stainless steel with hot, soapy water and a dishcloth. Rinse with clean water and a cloth. Do not use cleaners with high concentrations of chlorides or chlorines. Do not use harsh scrubbing cleaners. Only use kitchen cleaners that are especially made for cleaning stainless steel.

Solutions to Common Problems

IMPORTANT:

Before calling for service, review this list. It may save you both time and expense. This list includes common experiences that are not the result of defective workmanship or material in your cooktop.

| PROBLEM | POSSIBLE REASONS | | SOLUTIONS |
|---|--|---|---|
| No spark occurs when lighting burner | Burner cap | The burner is not installed correctly. | Install the burner pieces again. |
| | Igniter | Check all connections to the ignition module. | |
| | | Igniter is not positioned correctly. | Adjust the distance by 3 - 4mm |
| | | Igniter is broken. | Replace with supplied igniter. Note: There are two igniter sizes: - large for the triple ring burner - small for all other burners |
| | Electricity | Ensure electric current to small black box on gas valve is running. | Reset the electrical breaker if necessary. |
| | | The electrical wires or the plug are not connected well. | Connect with electrical power again. |
| The flame goes out once the knob is released | Thermocouple | Burner knob not pressed down long enough. | Press and turn the burner knob again and keep holding for 5 to 10 seconds after the burner has been lit. |
| | | Attach thermocouple to a functional gas valve to determine if the issue is the thermocouple or the gas valve. | If problem is the thermocouple, replace with supplied thermocouple Note: There are two thermocouple sizes: - large for the triple ring burner - small for all other burners |
| | | | If problem is the gas valve, contact the vendor. |
| Burner won't ignite or burns unevenly | Gas valve | The gas valve is not open or completely open. | Make sure the gas valve is completely open. |
| | Gas pipe | There may be air in the gas pipe. | Ignite repeatedly until flame catches. |
| | Gas connecting pipes | The gas connecting pipes are blocked. | Adjust or change the connecting pipes. |
| | Burner cap | The burner cap is not placed correctly. | Install the burner pieces again. |
| | | Some holes in the burner cap lid are blocked. | Clean the holes in the burner cap. |
| Igniter | The igniter is wet or contaminated by food residue | Clean and dry the igniter. | |

| PROBLEM | POSSIBLE REASONS | | SOLUTIONS |
|--|-------------------------|---|---|
| The flame goes out during operation | Thermocouple | The thermocouple is contaminated by food residue. | Clean the thermocouple. |
| | | The flame is too low and cannot reach the thermocouple. | Adjust the flame a little higher. |
| Flame is too high | Nozzle | The burner is connected with a natural gas nozzle and needs to be connected with a propane nozzle | Change the natural gas nozzle to a liquid propane nozzle. (Use the supplied screwdriver when changing the nozzles. Never use an electric screwdriver or drill to remove/replace the nozzles or to make the hole larger.) |
| | Regulator | The regulator is set for natural gas use and needs to be switched to liquid propane. | Contact your local qualified service technician to set the regulator so that it is set for liquid propane. |
| Flame is too low | Nozzle | The burner is connected with a liquid propane nozzle and needs to be connected with a natural gas nozzle. | Change the liquid propane nozzle to a natural gas nozzle. (Use the supplied screwdriver when changing the nozzles. Never use an electric screwdriver or drill to remove/replace the nozzles or to make the hole larger.) |
| | Regulator | The regulator is set for liquid propane use and needs to be switched to natural gas. | Contact your local qualified service technician to set the regulator so that it is set for natural gas. |
| Gas not reaching the cooktop | Gas supply | Ensure the service valve is connected to the gas supply. | If not the valve is not connected, contact your local qualified service technician to connect the service valve to the gas supply. |
| | | The arrow on the regulator is not pointing towards the cooktop. | Contact your local qualified service technician to reverse the regulator so that the arrow is pointing towards the cooktop. |
| Strange smell | Gas leaking | The gas supply pipe is old and broken. | Contact your local qualified service technician to change the gas supply pipes. |
| | | The main burner is not lit. | Ignite again after there is no strange smell. |
| Hissing noise coming from burner | Burners | Only possible cause is burner pieces are not placed correctly on the burner support. | Install the burner pieces again. |

Installation Instructions

INSTALLATION AND SERVICE MUST BE PERFORMED BY A QUALIFIED INSTALLER.

IMPORTANT: SAVE THESE INSTRUCTIONS FOR LOCAL ELECTRICAL INSPECTOR'S USE.

READ AND SAVE THESE INSTRUCTIONS FOR FUTURE REFERENCE.

Advance Preparation

- **⚠** For proper operation of a gas appliance, the air necessary for the combustion of the gas must be able to flow into the room naturally. The air must flow into the room directly through openings in the outside walls. These openings must have an unobstructed cross-section not less than $2\text{m}^3/\text{h}$ for each kw of power (see total power in kw on the appliance).

- This opening must be constructed so that it will not be obstructed from inside or outside, or constructed close to the floor. The opening is recommended to be on the side opposite to that on which the flue gases are discharged.

- Avoid placing cabinetry directly above cooktop when possible. If cabinetry is used above cooking surface, use cabinets no more than 13" deep (see Figure 6).

- Working areas adjacent to the cooktop should have 18" minimum clearance between countertop and cabinet bottom.

Make sure the wall coverings, countertop and cabinets around the cooktop can withstand heat (up to 200° F) generated by the cooktop.

- Maintain 30" minimum clearance between cooktop surface and cabinets installed above the cooktop.

- **⚠** If range hood is installed above cooktop, maintain a 30" minimum clearance between

- A range hood with minimum 350 CFM that projects at least 5" beyond front of cabinets can reduce risk of burns caused by reaching over heated surface units.

cooktop and bottom of range hood. The range hood must be connected directly to flues or to the outside.

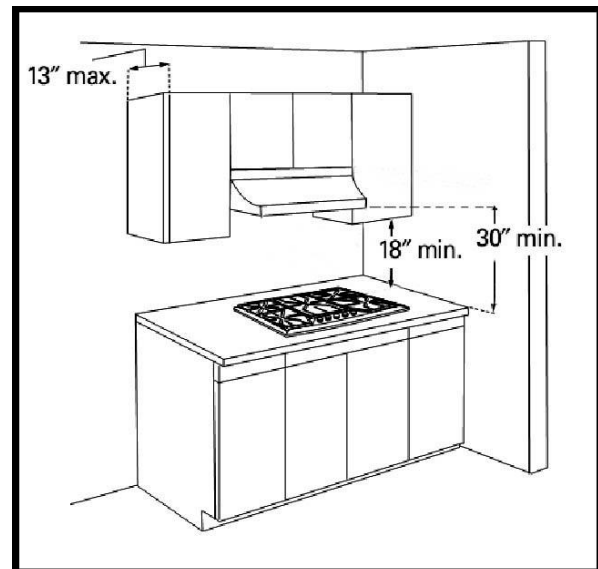

Figure 6

Provide an Adequate Gas and Electrical Supply

• **⚠** Installation must comply with local codes. In the absence of local codes, the gas cooktop must comply with the National Fuel Gas Code ANSI Z223.1—latest edition in the United States, or in Canada CAN/CGA B149.1, and CAN/CGA B149.2, and the National Electrical Code ANSI/NFPA No. 70—latest edition in United States, or in Canada CSA Standard C22.1, Canadian Electrical Code, Part 1, and local code requirements.

• Gas supply should be located near the opening for this cooktop and be a minimum of 1" from the back wall (see Figure 7). This cooktop is set for natural gas and is designed to operate at 5" water column pressure. The regulator is required to provide a minimum of 6" water column to a maximum of 14" water column to the cooktop regulator.

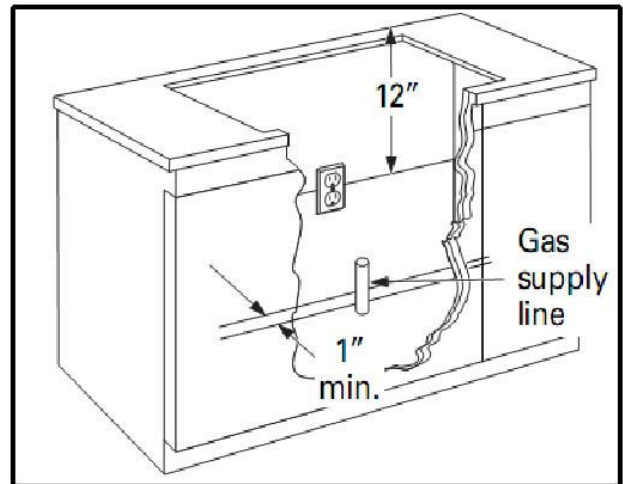

Figure 7

• The electric spark ignition feature for this model requires a 120V electrical power supply and should be located 12" below the countertop and within reach of the cooktop's four-foot power cord.

Tools and Materials Needed

MATERIALS YOU WILL NEED:



Joint Sealant



Pipe Fittings



Shut-Off Valve



CSA-Approved Flexible 1/2" or 3/4" Gas Line

TOOLS YOU WILL NEED:

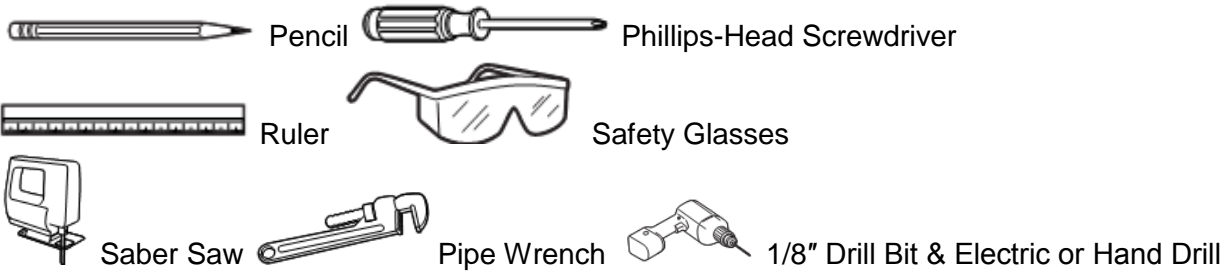

Cutting the Countertop

- 1) Use a 24" or deeper base cabinet.

Figure 8.1

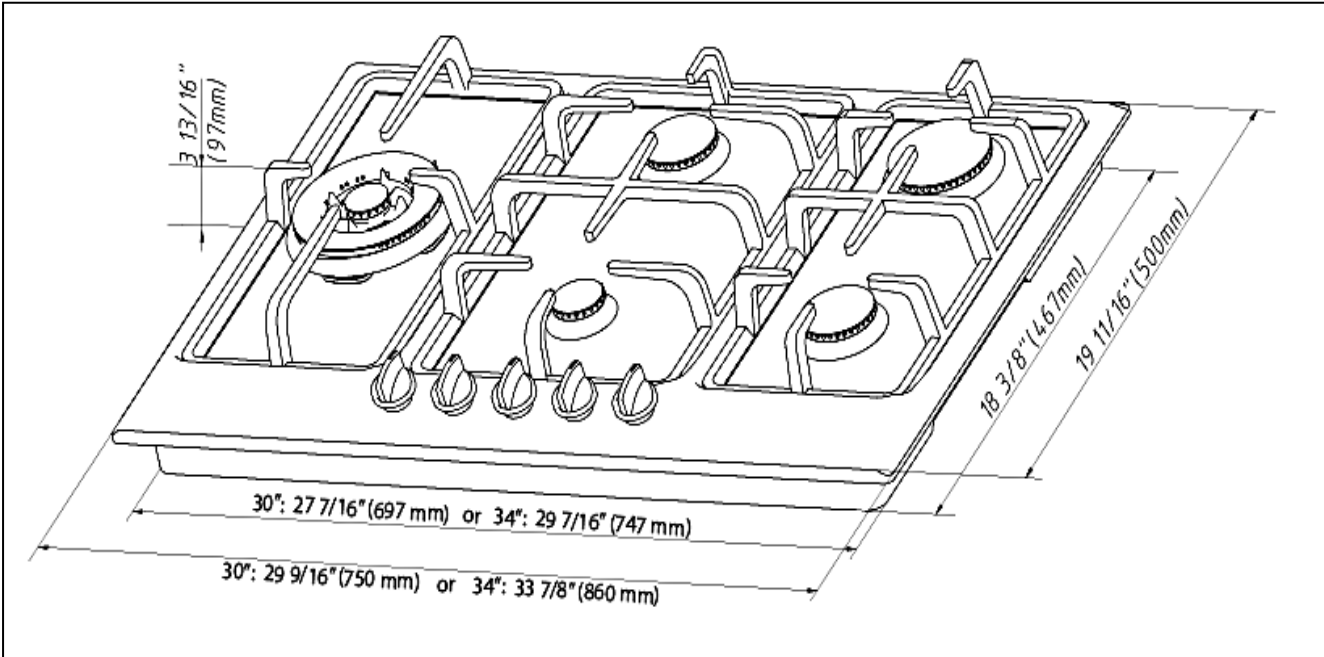
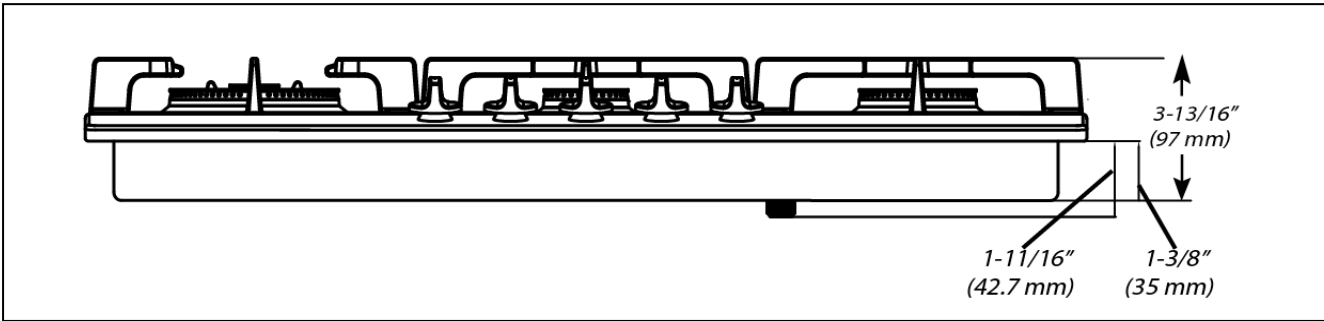

Figure 8.2

- 2) Cut the opening in the countertop. To ensure accuracy it is best to make a template (see Figure 9) for the opening. Make sure the sides are parallel also rear and front cuts are exactly

perpendicular to the sides. Observe all minimum clearances.

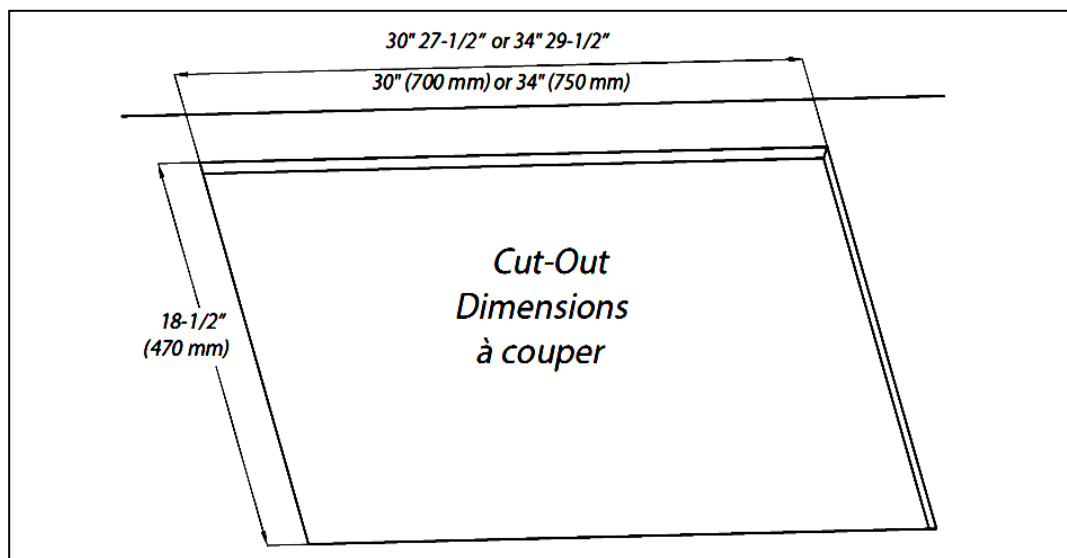

Figure 9

- 3) Before inserting the cooktop into the opening in the countertop, remove the grates and burner caps, turn the cooktop upside down and place the special foam gasket around the bottom edge of the cooktop (see Figure 10). It is important to fix this gasket evenly, without gaps or overlapping, to prevent liquid seeping underneath the cooktop.

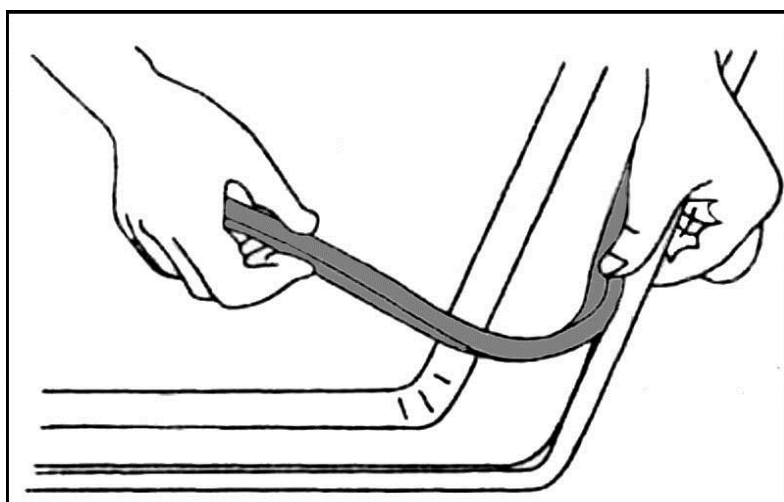

Figure 10

- 4) After the foam gasket has been affixed, place the cooktop into the countertop (see Figure 11).

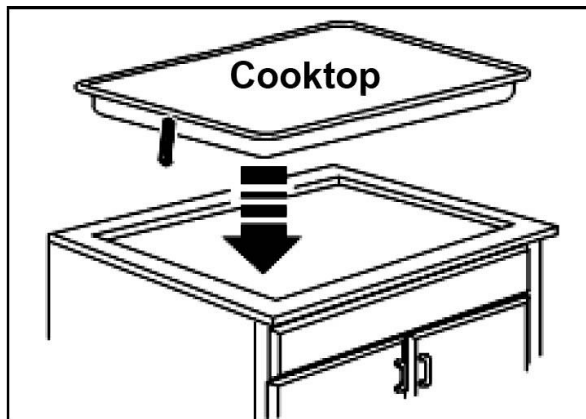

Figure 11

- 5) Secure cooktop from underneath with the supplied clips and screws (see Figure 12).

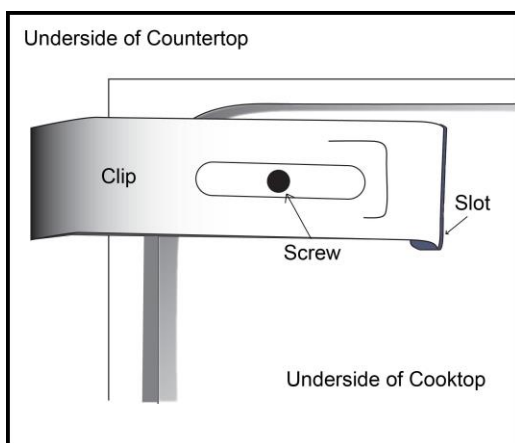

Figure 12

Installing the Pressure Regulator

⚠ WARNING: Never reuse old flexible connectors. The use of old flexible connectors can cause gas leakage and personal injury. Always use new flexible connectors when installing a gas appliance. To reduce the possibility of gas leakage, apply Teflon tape or a thread compound approved for use with LP or Natural gases to all threaded connections.

- This cooktop is set for **natural gas** and is designed to operate at 5" water column pressure. The gas supply is required to provide a minimum of 6" to a maximum of 14" water column pressure to the cooktop regulator.
- If the cooktop is converted for **liquid petroleum (LP) gas**, the LP gas supply is required to provide a minimum of 10" to a maximum of 14" water column to the cooktop regulator.
- The pressure regulator must be connected in series with the manifold of the cooktop and must remain in series with the supply line regardless the type of gas being used.

• **⚠** The gas supply line must be equipped with an approved manual shut-off valve. In an easily accessible location in the same room as the cooktop. Do not block access to the shutoff valve. Be sure you know how and where to shut off the gas supply to the cooktop. Install the electrical outlet 12" below the countertop (see Figure 13).

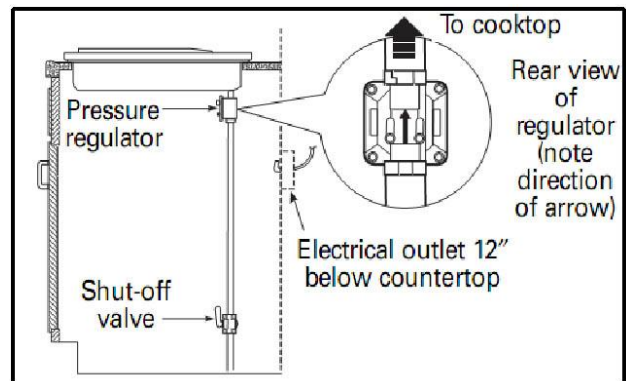

Figure 13

- 1) The gas inlet is located on the bottom of the cooktop at the rear and 8 ½" from the right hand edge of the cooktop. Make gas connection through rear wall, or on cabinet floor at rear. Install the house gas supply at least 1" from the back wall.
- 2) When installing, fit a safety tap at the end of the pipeline. The appliance leaves the factory tested and set for natural gas. Make sure that the type of gas to be supplied to the appliance is the same as that shown on the label affixed to the underside of the cooktop.
- 3) Make the connection to the gas system using a rigid ½" or ¾" metal pipe and regulation unions, or with a stainless steel hose complying with the local standard. If metal hoses are used, take care that they do not come into contact with mobile parts and are not crushed. This must also be checked if the cooktop is to be combined with an oven.

- 4) The gas intake connection of the appliance has a “male thread.” When making the connection, take care not to apply stresses of any kind to the appliance. Over-tightening may crack the regulator resulting in a gas leak and possible fire or explosion (see Figure 14).

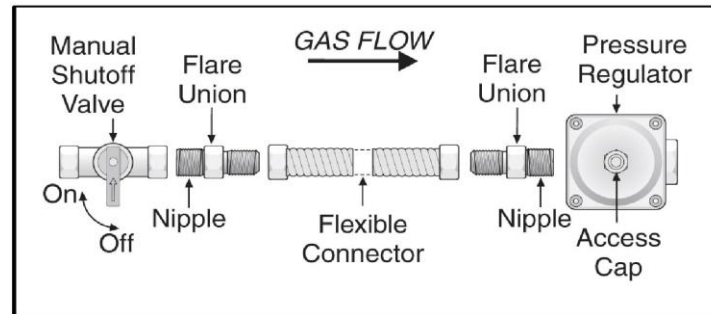

Figure 14

- 5) Once regulator is in place, open the shutoff valve in the gas supply line. Wait a few minutes for gas to move through the gas line.
- 6) After connecting the cooktop to the gas supply, make sure all burners knobs are in the OFF position and check the system for leaks with a manometer. If a manometer is not available, turn on the gas supply and use a liquid leak detector (or soap and water) at all joints and connections to check for leaks.

- **Warning** - Do not use a flame to check for leaks from gas connections. Checking for leaks with a flame may result in a fire or explosion.

- **Tighten all connections** if necessary to prevent gas leakage in the cooktop or supply line.

- **Check alignment of control knob valves** after connecting the cooktop to the gas supply to be sure the cooktop manifold pipe has not moved. A misalignment could cause the valve stems to rub on the control panel, resulting in a gas leak at the valve.

- **Disconnect this cooktop and its individual manual shutoff valve** from the gas supply piping system during any pressure testing of that system at test pressures greater than 1/2 psig (3.5 kPa or 14" water column).

- **⚠ Isolate the cooktop from the gas supply piping system** by closing its individual manual shutoff valve during any pressure testing of the gas supply piping system at test pressures equal to or less than 1/2 psig (3.5 kPa or 14" water column).

Electrical Connection

Before making the connection, make sure that:

- 1) The safety circuit-breaker and the electrical system are able to with stand the load of the appliance.
- 2) The power supply system has a ground connection in good working order in accordance with the regulations in force.
- 3) The electrical socket is easily accessible with the appliance installed. In all cases, the power supply lead must be positioned so that it does not reach a temperature 50°C above the room temperature at any point.
- 4) If installed above a built-in oven, the cooktop cable must not touch the oven below (see Figure 15).

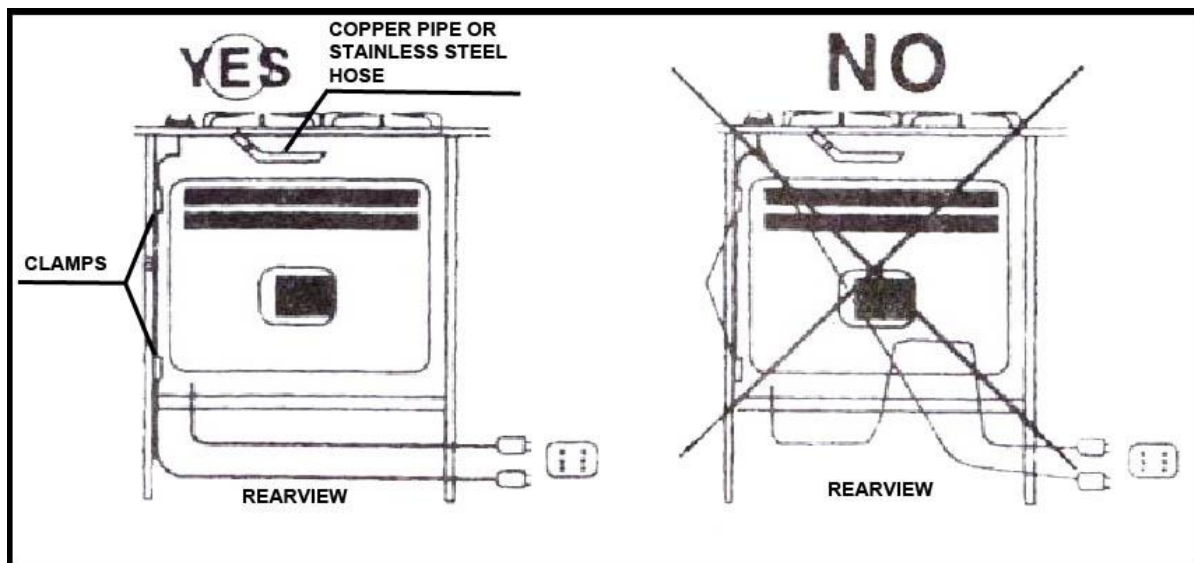

Figure 15

Assembling the Burners

The electrode of the electronic ignition system is positioned above the surface of the burner base. Do not remove a burner cap or touch the electrode of a burner while another is turned on. Damage or electrical shock may occur.

1. Place burner heads over the burner base. Make sure the hole in the burner head is properly aligned with the electrode in the burner base (see Figure 16).
2. Place the burner caps on the burner heads. Make sure that the burner caps are properly seated on the burner head (see Figure 17).

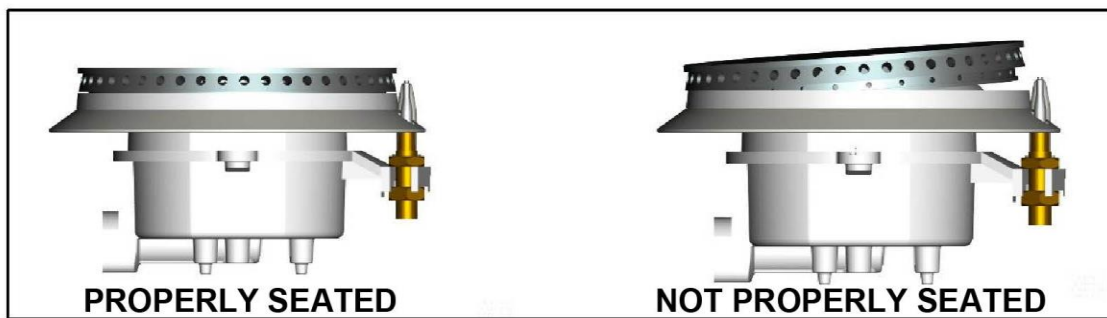
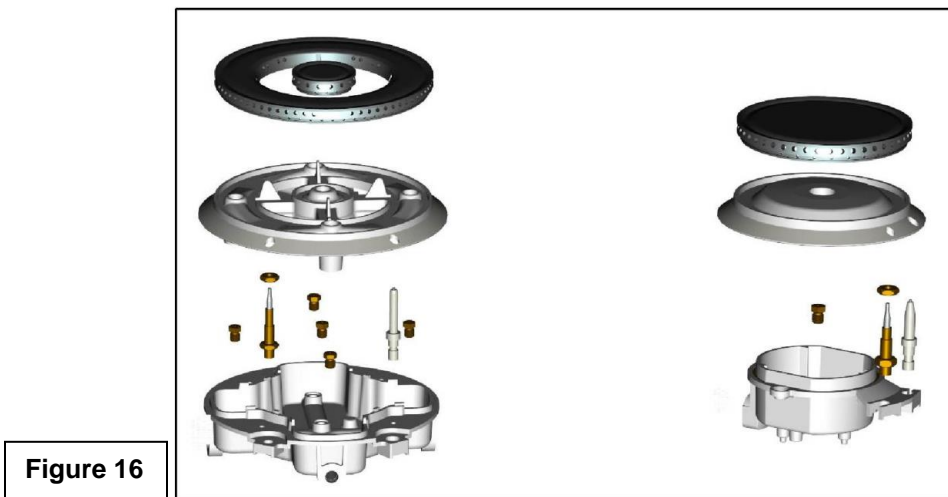

Figure 17

3. Operation of the electric igniters should be tested after the cooktop and supply line have been carefully checked for leaks and the cooktop has been connected to the electrical power. To check igniters, push and turn a burner valve to the LITE position. All spark igniters will make a series of sparks (ticking sounds), but only the burner turned to LITE will light.

LP/Propane Gas Conversion

This appliance can be used with **Natural Gas** or LP/Propane gas. It is shipped from the factory for use with natural gas. A kit for converting to LP gas is supplied with your cooktop. The kit is marked "FOR LP/PROPANE GAS CONVERSION".

When the cooktop is converted for **liquid petroleum (LP) gas**, the LP gas supply is required to provide a minimum of 10" to a maximum of 14" water column to the cooktop regulator.

⚠ The conversion must be performed by a qualified service technician in accordance with the kit instructions and all local codes and requirements. Failure to follow instructions could result in serious injury or property damage. The qualified agency performing this work assumes responsibility for the conversion. ⚠

| BURNER TYPE | MAX OUTPUT | MIN OUTPUT | Natural Gas | | LPG | |
|--------------------|------------|------------|-------------|------------------------|-----------|----------|
| | BTU | BTU | Nozzle mm | Cons M ³ /h | Nozzle mm | Cons g/h |
| Auxiliary Burner | 5000 | 1023 | 1 x 1.10 | 0.13 | 1 x 0.70 | 115 |
| Semi-Rapid Burners | 6800 | 1887 | 1 x 1.20 | 0.18 | 1 x 0.80 | 150 |
| Rapid Burner | 8500 | 2730 | 1x 1.45 | 0.22 | 1 x 0.91 | 197 |
| Triple Ring Burner | 16000 | 5119 | 5 x Φ0.93 | 0.41 | 5 x Φ0.56 | 352 |

Figure 18

⚠ WARNING ⚠

Failure to make the appropriate conversion can result in serious personal injury and property damage.

TOOLS YOU WILL NEED FOR CONVERSION



Wrench



7mm Nut Driver



Safety Glasses



Small Flat-head Screwdriver (2 to 2.4 mm or 3/32" tip size, 60 mm long)

A. ADJUST THE REGULATOR

- a) Disconnect all electrical power, at the main circuit breaker or fuse box.
- b) Shut off the gas supply to the cooktop by closing the manual shut-off valve.
- c) Adjust the pressure regulator by doing the following:

- 1) Unscrew the regulator cap with the wrench (see Figure 19).



Figure 19

- 2) This is how the retainer pin looks for Natural Gas usage (see Figure 20).



Figure 20

- 3) Remove the retainer pin (see Figure 21).



Figure 21

- 4) Reverse the retainer pin and put back into the regulator cap. This is how the regulator pin looks for LP gas usage (see Figure 22).



Figure 22

- 5) Screw the regulator cap back into the regulator and re-attach the regulator to the nipple and flare union (see Figures 14 and 23).



Figure 23

B. CHANGE BURNER NOZZLES

INSTALLATION TIP: First remove all nozzles and then start replacing them. This will help to prevent the possibility that some may not be replaced.

- 1) Remove the burner grates, burner caps and burner heads.
- 2) Using a 7mm nut driver, remove the burner nozzles.

⚠ IMPORTANT: Carefully read and observe each nozzle label for correct location (see Figure 18).

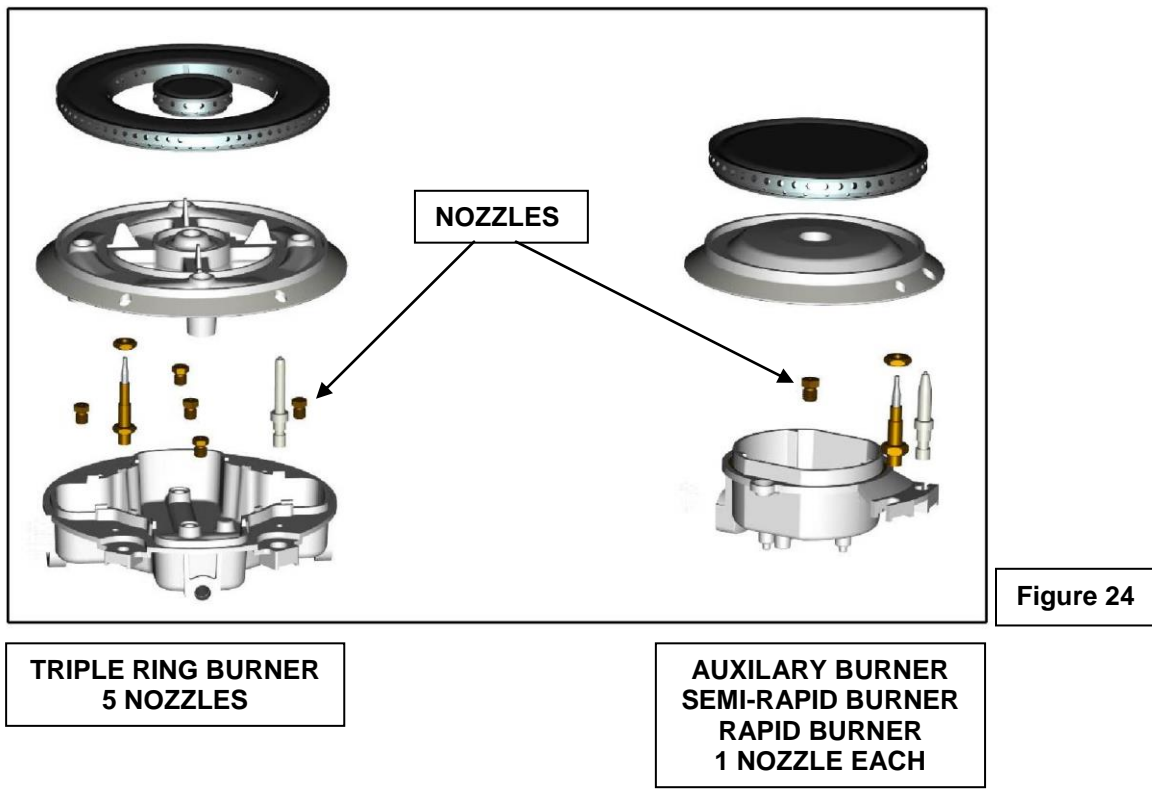

- 3) Install the proper nozzles in the exact locations as noted in the illustrations above (see Figure 24).
- 4) Replace the burner bases, heads, caps and top grates. Make sure burner caps are properly seated on the burner head (see Figure 17).

C. ADJUST BURNER FLAMES

- 1) Turn all burners on highest setting and check the flames. They should be blue in color and may have some yellow tipping at the ends of the flame when using LP gas. Foreign particles in the gas line may cause an orange flame at first, but this will soon disappear.
- 2) Turn the cooktop burner knob to “LO” while observing the flame.
- 3) Adjustments must be made with two other burners in operation on a medium setting. This prevents the upper row of flames from being set too low, resulting in the flame being extinguished when other burners are turned on.

- To adjust the flame, remove the knobs, insert a screwdriver through the access hole in valve shaft as shown (see Figure 25). Make the adjustment by slowly turning the screw until flame appearance is correct.

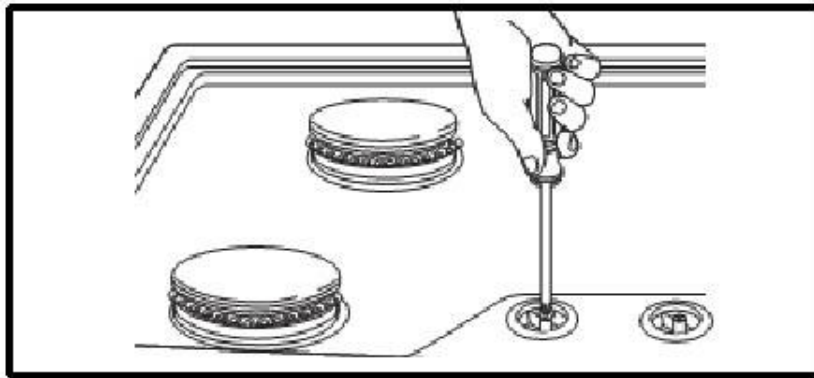

Figure 25

- If the flames are too small or fluttered, open the valve more than the original setting.
- If the flames are too large, close the valve more than the original setting.

D. TESTING FLAME STABILITY

Test 1—Turn the knob from “HI” to “LO” quickly. If the upper row of flames goes out at this setting, increase the flame size and test again.

Test 2—With the burner on “LO”, open and close the cabinet door under the cooktop. If the flame is extinguished by the air currents created by the door movement, increase the flame height and test again.

E. FLAME RE-CHECK

After the adjustment is made, turn all burners off. Ignite each burner individually. Observe the flame at the “HI” position. Rotate the knob to the lowest setting and be sure that the flame size decreases as the knob is rotated counter-clockwise.

⚠ Once the conversion has been completed and has passed testing, fill out the conversion sticker and include your name, organization and the date conversion is made. Apply the sticker near the cooktop gas inlet opening to alert others in the future that this appliance has been converted. If converting back to Natural Gas, please remove the sticker so others know that the appliance is set to use its original gas.