

**AMICONA<sup>®</sup>**

**Range Hood  
Pro UC Electronic  
Controls  
LED**

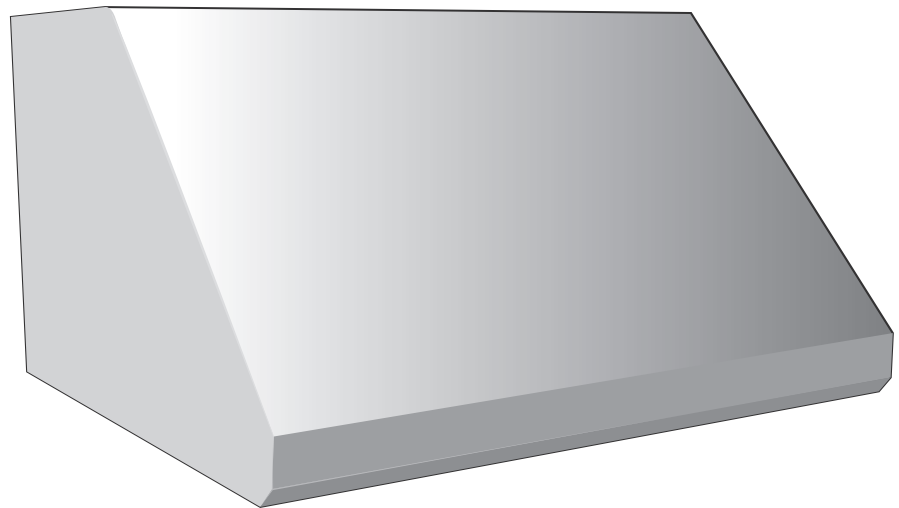

**User Manual  
&  
Installation Instructions**

**IMPORTANT SAFETY INSTRUCTIONS**  
Carefully read the important information regarding  
installation, safety and maintenance.  
Keep these instructions for future reference.

MAAN1244-03  
2017-08-09

# Before You Begin

## **INSTALLERS - Start Here**

**Safety Instructions are on pages 4 and 5 and Installation Instructions are on pages 6 to 14.**

Please perform these steps:

1. Read the safety instructions.
2. Read all instructions in the Installation section of this manual BEFORE installing the range hood.
3. Remove all packing materials.
4. When finished, make sure to leave these instructions with the consumer.
5. Installation is to be done by a qualified technician only. However the ultimate responsibility for proper installation falls to the owner.
6. Product failure due to improper installation is not covered under the Warranty.



## **CONSUMERS - Start Here**

**Safety Instructions are on pages 4 and 5 and Operating Instructions are on pages 15 and 16.**

Please perform these steps:

1. Read the safety instructions.
2. Read all instructions in the manual BEFORE operating the range hood.
3. Remove all packing materials.
4. Installation is to be done by a qualified technician only. However the ultimate responsibility for proper installation falls to the owner.
5. Product failure due to improper installation is not covered under the Warranty.

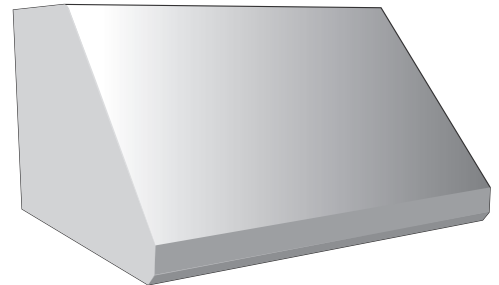

**Hardware Note:** For safety reasons, range hood mounting screws and anchors will not be included due to the variation of cabinetry constructions and wall material. Please consult your installation specialist regarding the optimal type of mounting screws and wall anchors to suit your home's construction.

# Table of Contents

Before You Begin.....	2
Table of Contents .....	3
Important Safety Information .....	4
Included Parts .....	6
Range Hood Dimensions .....	7
Specifications.....	7
Installation.....	6
Step 1 - Read the Safety Instructions.....	8
Step 2 - Unpack Range Hood and Prepare Tools.....	8
Step 3 - Plan Desired Location .....	8
Step 4 - Test Unit Functions .....	8
Step 5 - Venting Installation Guides.....	9
Step 6 - Install Wood Support.....	10
Step 7 - Install Range Hood Mounting Screws.....	10
Step 8 - Mount the Range Hood.....	11
Step 9 - Secure Back of Range Hood .....	11
Step 10 - Install Damper Adapter and Damper .....	12
Step 11 - Connect Ductwork .....	12
Step 12 - Connect to AC.....	13
Step 13 - Install Grease Trays .....	14
Step 14 - Install Baffle Filters .....	14
Operation .....	15
Using the Fan.....	15
Using the Time Delay Function .....	15
Turning the Light On or Off.....	15
Maintenance.....	16
Replacing the Light Bulbs.....	16
Cleaning the Range Hood.....	16
Replacement Parts.....	17

# Important Safety Information

## READ ALL INSTRUCTIONS BEFORE USE

Read and follow all instructions before using the range hood to prevent the risk of fire, electric shock, personal injury, or damage when using the range hood or appliances with the range hood. This guide does not cover all possible conditions that may occur. Always contact your service technician or manufacturer about problems that you do not understand.

- The installation in this manual is intended for qualified installers, service technicians or persons with a similar qualified background. Installation must be done by qualified professionals and in accordance with all applicable codes and standards, including fire-rated construction.
- The range hood may have very sharp edges; please wear protective gloves if it is necessary to remove any parts for installing, cleaning or servicing.
- Activating any switch to ON position before completing installation may cause damage or electric shock.
- Due to the size of this range hood, two person installation is recommended.

### To reduce the risk of fire, electric shock, or injury to persons:

- For general ventilating use only. **DO NOT** use to exhaust hazardous or explosive materials and vapors.
- **WARNING:** To Reduce The Risk Of Fire Or Electric Shock, Do Not Use This Fan With Any Solid-State Speed Control Device.
- The combustion air flow needed for safe operation of fuel-burning equipment may be affected by this unit's operation. Follow the heating equipment manufacturer's guideline and safety standards such as those published by the National Fire Protection Association (NFPA), and the American Society of Heating, Refrigeration and Air Conditioning Engineers (ASHRAE), and other local code authorities.
- Before servicing or cleaning the unit, switch power off at service panel and lock the service

disconnecting means to prevent power from being switched on accidentally. When the service disconnecting means cannot be locked, securely fasten a prominent warning device, such as a tag, to the service panel.

- Clean grease-laden surfaces frequently. To optimize performance and to disperse air properly, make sure to vent air outside. **DO NOT** vent exhaust into spaces between walls, crawl spaces, ceilings, attics or garages.
- Ducted fans **MUST** always be vented to the outdoors.
- This unit **MUST** be grounded and use only metal ductwork.
- Sufficient air is needed for proper combustion and exhausting of gases through the duct to prevent back drafting.
- When cutting or drilling into wall or ceiling, be careful not to damage electrical wiring or other hidden utilities.
- All electrical wiring must be properly installed, insulated and grounded.
- Old ductwork should be cleaned or replaced if necessary to avoid the possibility of a grease fire.
- Check all joints on ductwork to ensure proper connection; all joints should be properly taped using a certified aluminum or foil tape.
- Use this unit only in the manner intended by the manufacturer. If you have questions, contact the vendor.

## READ AND SAVE THESE INSTRUCTIONS

# Important Safety Information

## **WARNING: TO REDUCE RISK OF A RANGE TOP GREASE FIRE:**

- a) Never leave surface units unattended at high settings. Boilovers cause smoking and greasy spillovers that may ignite. Heat oils slowly on low or medium settings.
- b) Always turn range hood ON when cooking at high heat or when flambéing food (i.e. Crepes Suzette, Cherries Jubilee, etc.).
- c) Clean ventilating fans frequently. Grease should not be allowed to accumulate on fan or filter. Before servicing or cleaning unit, unplug and disconnect the hood from the power supply.
- d) Use proper pan size. Always use cookware appropriate for the size of the surface element.

## **WARNING: TO REDUCE RISK OF INJURY TO PERSONS IN THE EVENT OF A RANGE TOP GREASE FIRE, OBSERVE THE FOLLOWING \***

- a) **SMOTHER FLAMES** with a close-fitting lid, cookie sheet, or metal tray, then turn off the burner. **BE CAREFUL TO PREVENT BURNS.** If the flames do not go out immediately, **EVACUATE AND CALL THE FIRE DEPARTMENT.**
- b) **NEVER PICK UP A FLAMING PAN** - You may be burned.
- c) **DO NOT USE WATER**, including wet dishcloths or towels - a violent steam explosion will result.
- d) Use an extinguisher **ONLY** if:
  - 1) You know you have a Class A, B, C extinguisher, and you already know how to operate it.
  - 2) The fire is small and contained in the area where it is started.
  - 3) The fire department is being called.
  - 4) You can fight the fire with your back to an exit.

\* Based on "Kitchen Fire Safety Tips" published by NFPA

## **To reduce the risk of injury to persons in the event of a gas leaks:**

- Extinguish any open flame.
- **DO NOT** turn on the lights or any type of appliance.
- Open all doors and windows to disperse the gas. If you still smell gas, call the gas company and fire department.

Your safety and the safety of others is very important. We have provided many important safety messages in this manual and on your appliance. Always read and obey all safety messages. All safety messages outline any potential hazards, how to reduce the chance of injury, possible risks if the instructions are not followed.

## **READ AND SAVE THESE INSTRUCTIONS**

# Included Parts

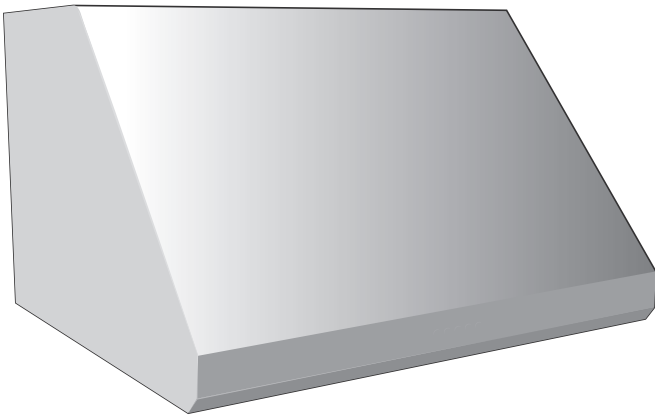

Range Hood

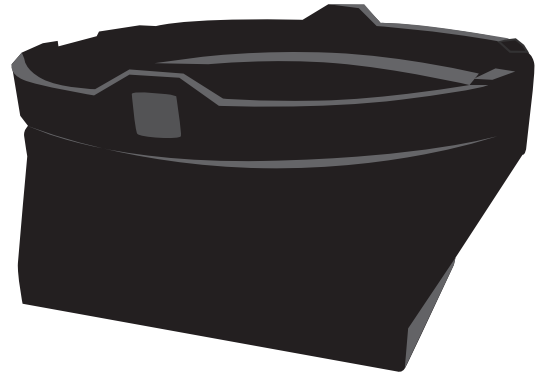

Damper

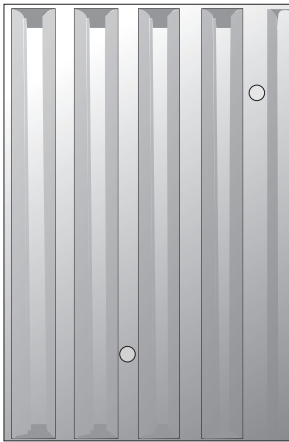

Baffle Filters x 3

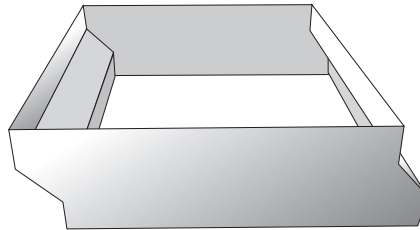

Damper Adapter  
(already installed)



Damper Screws x 4

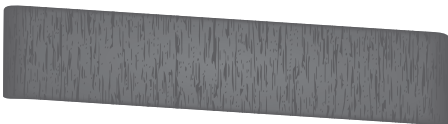

Wood Support

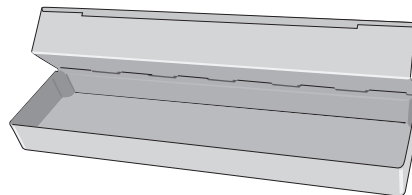

Grease Tray x 3



**Hardware Note:** For safety reasons, range hood mounting screws and anchors will not be included due to the variation of cabinetry constructions and wall material. Please consult your installation specialist regarding the optimal type of mounting screws and wall anchors to suit your home's construction.

# Range Hood Dimensions

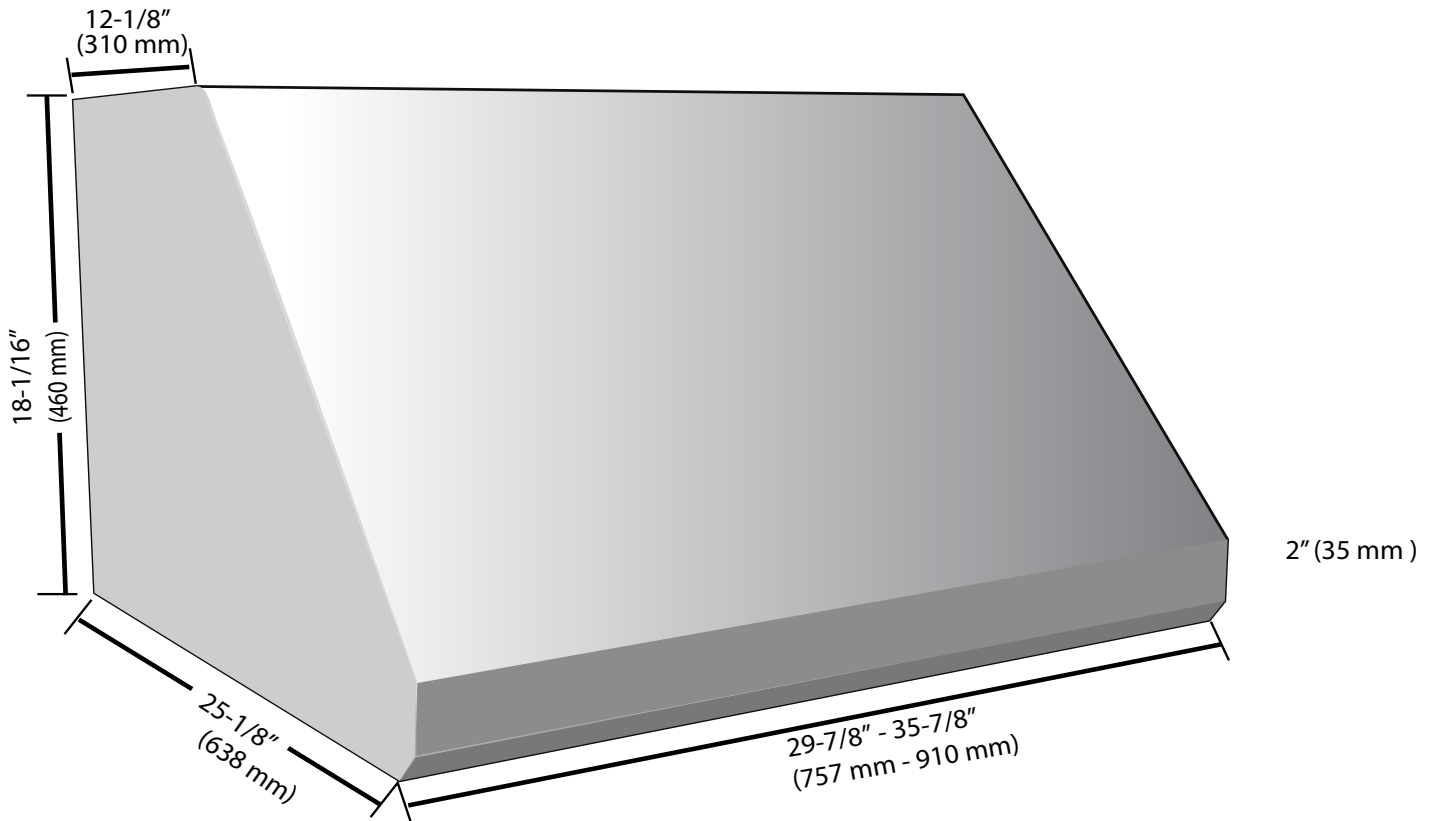

## Specifications

Body Design	Stainless Steel
Power Rating	120 V / 60 Hz (cETLus Certified)
Total Input Power	506 W
Motor Input Power	500 W
Total Amps	4.5 A
Speed Control Levels	4 Levels
Interference Levels	Radio Frequency Interference Protected
Airflow	850 CFM
Motors	2 Motors
Control	Electronic Controls
Filtration	Stainless Steel Baffle Filters
Illumination	2 x 3 W LED Lamps
Venting Size	10" (254 mm)



# Installation

---

## STEP 1

### Read the Safety Instructions

- It is very important to read the safety instructions on pages 4 and 5.

**IMPORTANT: It is the installer's responsibility to comply with installation clearances.**

---

## STEP 2

### Unpack Range Hood and Prepare Tools

- Carefully unpack the range hood and parts. Make sure all parts are included as shown on page 6.
  - DO NOT remove the protective film covering the appliance until the installation is fully completed.
  - Consult a qualified and trained installer or check local codes for makeup air requirement, if any.
- 

## STEP 3

### Plan Desired Location

- Plan a desirable location that fits all requirements in the Safety and Installation sections of this manual. Plan where and how the ductwork will be installed.
  - A straight or short duct run will allow the unit to perform most efficiently. Long duct runs, elbows and transitions will reduce the performance of the unit. Each elbow is equivalent to 5 to 10 feet of straight run. Proper size duct work should be 10 inches (254 mm) in diameter.
  - If ductwork is already installed: ensure unit is free from debris and is connected to a 10" (254 mm) duct (reducers may be used, sold separately).
  - Only one flange is needed in the air duct system, either on top of the motor (provided) or outside.
  - **This unit's damper is located 18" (460 mm) from bottom of range hood, therefore rear venting requires a higher wall aperture for duct than standard. Please calculate position for duct on wall BEFORE installing this product (See Height and Clearance illustration on page 9).**
- 

## STEP 4

### Test Unit Functions

- Plug the unit in and test all of the functions before installing.
- 

#### **WARNINGS:**

- Please make sure to read ALL safety instructions on pages 4 and 5.
- Use two or more people to move and install range hood.
- Failure to follow these instructions can result in serious injury.



# Installation

## STEP 5

### Venting Installation Guidelines

#### IMPORTANT:

- Vent system must terminate to the outside (roof or side wall).
- DO NOT terminate the vent system in an attic or other enclosed area.
- DO NOT use 4" (10.2 cm) laundry-type wall caps.
- Use metal/aluminum vent only. A rigid metal/aluminum vent is recommended.
- DO NOT use a plastic vent.
- Always keep the duct clean to ensure proper airflow.
- Calculate the following figures before installation:
  1. Distance from the floor to the ceiling
  2. Distance between the floor and the countertop/stove
  3. A distance of 24" to 30" is recommended between stove top and the bottom of range hood. 30" minimum is required for gas stove tops.
  4. Height of hood and duct cover.

#### For the most efficient and quiet operation:

- It is recommended that the range hood be vented vertically through the roof through 10" (15.3 cm) or bigger round metal/aluminum vent work.
- The size of the vent should be uniform.
- Use no more than three 90° elbows.
- Make sure there is a minimum of 24" (61 cm) of straight vent between the elbows if more than one elbow is used.
- DO NOT install two elbows together.
- The length of vent system and number of elbows should be kept to a minimum to provide efficient performance.
- The vent system must have a damper. If roof or wall cap has a damper, you may remove damper flaps from damper to increase air flow.
- Use silver tape or duct tape to seal all joints in the vent system.
- Use caulking to seal exterior wall or roof opening around the cap.

### Height and Clearance

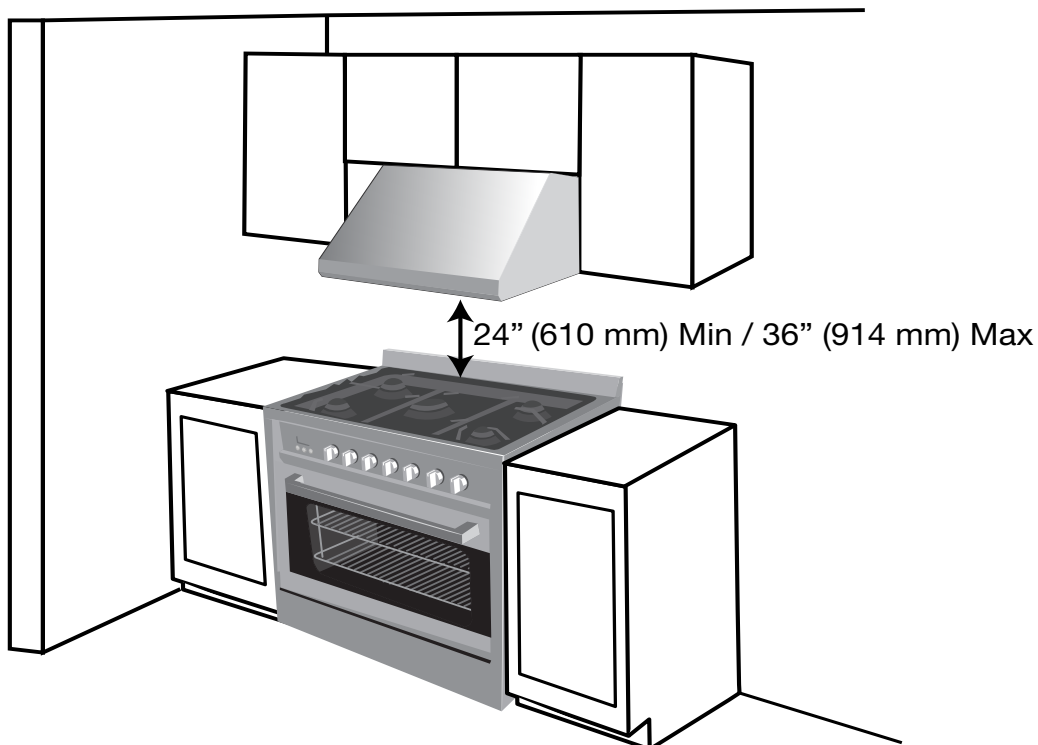



# Installation

## STEP 8

### Mount the Range Hood

- Lift the range hood and place over the protruding mounting screws; the keyhole slots on the top of the range hood should engage with the protruding mounting screws.
- Gently slide the range hood backwards until it cannot slide back any further. Finish screwing in the mounting screws.

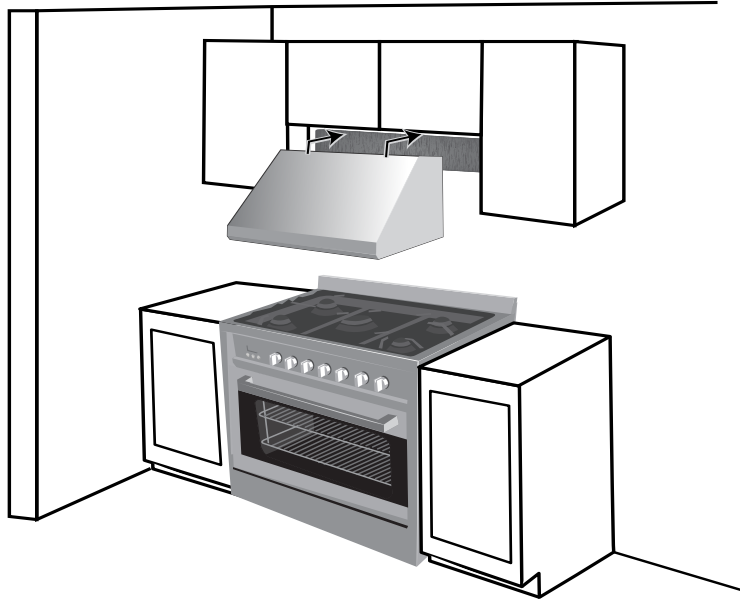

#### Notes:

- Please make sure to read ALL safety precautions on pages 4 and 5.
- Check to be sure the range hood is level and centered.

## STEP 9

### Secure Back of Range Hood

- Using two wood screws (not provided), secure the back of the range hood into the wood support through the two keyhole slots in the rear of the range hood body.

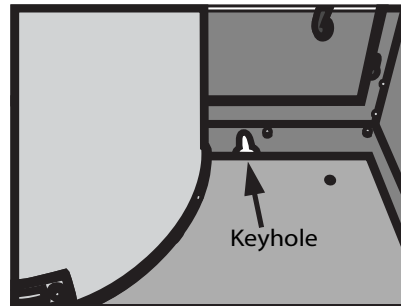
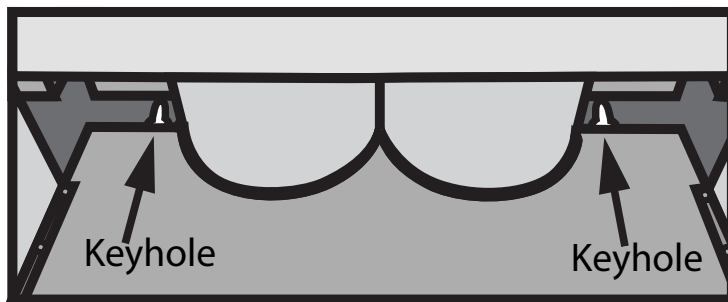

**Hardware Note:** For safety reasons, range hood mounting screws and anchors will not be included due to the variation of cabinetry constructions and wall material. Please consult your installation specialist regarding the optimal type of mounting screws and wall anchors to suit your home's construction.

# Installation

## STEP 10

### Install Damper

- Position the damper over the damper adapter and secure using the screws provided.

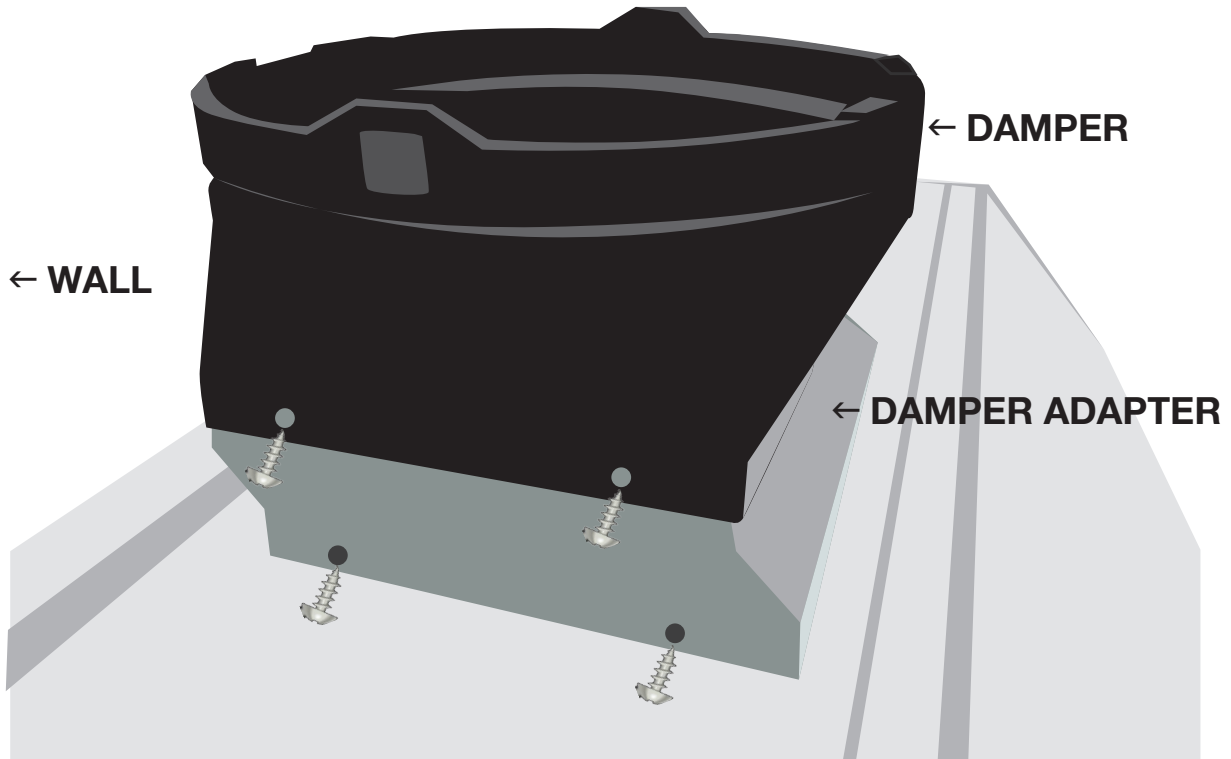

## STEP 11

### Connect Ductwork

- Attach ductwork to damper. Secure the ductwork with duct tape to make joints are secure and air-tight.
- Do not install the duct tape too tightly as this may prevent the damper flaps from opening which will overwork the motor and cause improper functioning of the unit.
- Fasten all connections with sheet metal screws and tape all joints with certified aluminum or foil tape. Use caulking to seal exterior wall or roof opening around the cap.

# Installation

## STEP 12

### Connect to AC

- Connect AC plug into a grounded AC outlet having 120V, 60Hz. Place the outlet at a maximum distance of 33-1/2" (851 mm) from where the cord exits on the hood.
- SEE IMPORTANT INSTRUCTIONS BELOW

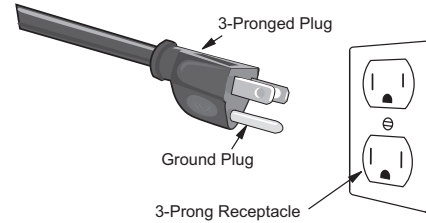

#### IMPORTANT:

- Observe all governing codes and ordinances.
- **It is the customer's responsibility to contact a qualified electrical installer.**
- If codes permit and a separate ground wire is used, it is recommended that a qualified electrician determine that the ground path is adequate. A 120-Volt, 60 Hz, AC-only, fused electrical supply is required on a separate 15-amp circuit, fused on both sides of the line.
- DO NOT ground to a gas pipe.
- Check with a qualified electrician if you are not sure that the range hood is properly grounded.
- DO NOT have a fuse in the neutral or ground circuit.

**IMPORTANT: Save this Installation Guide for electrical inspector's use.**

#### GROUNDING INSTRUCTIONS:

- This appliance must be grounded. In the event of an electrical short-circuit, grounding reduces the risk of electric shock by providing an escape wire for the electric current.
- This appliance is equipped with a cord having a grounding wire with a grounding plug. The plug must be plugged into an outlet that is properly installed and grounded.

**WARNING:** Improper grounding can result in a risk of electric shock.

- Consult a qualified electrician if the grounding instructions are not completely understood, or if doubt exists as to whether the appliance is properly grounded. DO NOT use an extension cord. If the power supply cord is too short, have a qualified electrician install an outlet near the appliance.

# Installation

## STEP 13

### Install Grease Trays

- Place the grease trays into the track at the back of the range hood.
- Slide them left and right until all trays are placed side-by-side in the track.
- The baffle filters and grease trays should be cleaned once a month, or as needed. See page 16 for cleaning instructions.



## STEP 14

### Install Baffle Filters

- Hold the baffle filter by the two knobs.
- Place the front of the baffle against the interior front of the range hood.
- Slide it up and push the rear of the filter back until it sits securely.
- The baffle filters channel grease released by cooking foods into the grease trays and prevent flaming foods on the cook top from damaging the inside of the range hood. For this reason, the baffle filters must ALWAYS be installed during range hood use.
- The baffle filters and grease trays should be cleaned once a month, or as needed. See page 16 for cleaning instructions.

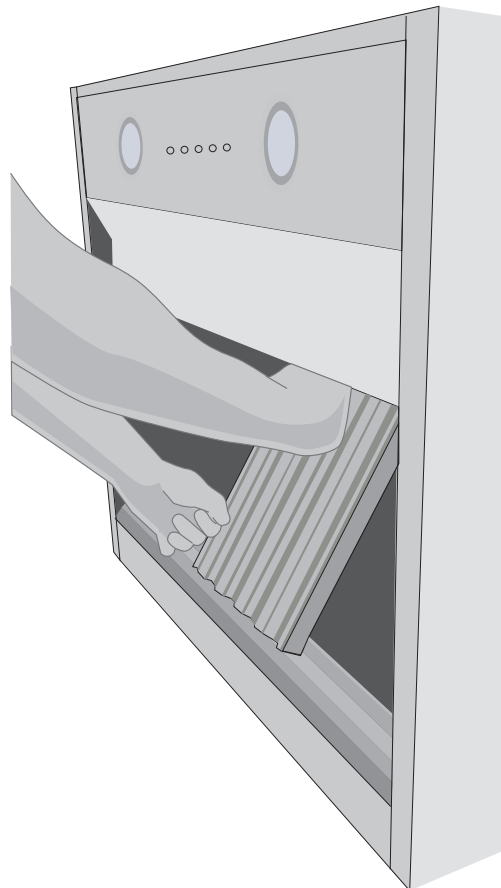

# Operation

## Using the Fan

- 1 Press the ① button to turn on the fan and set it to slow speed; the button will light up. Press the same button to turn the fan off.

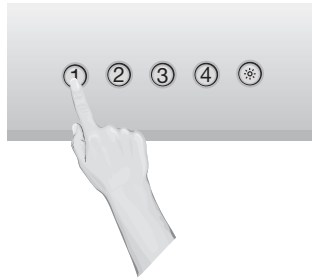

- 2 Press the ② button to increase the speed to the second setting; the ② button will light up.

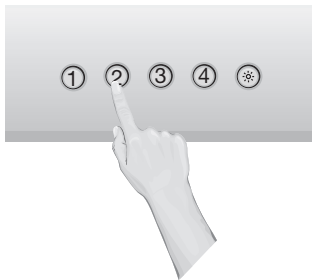

Press the ③ button again to increase the speed to the third setting; the ③ button will light up.

- 3 Press the ④ button again to increase the speed to the fourth setting.

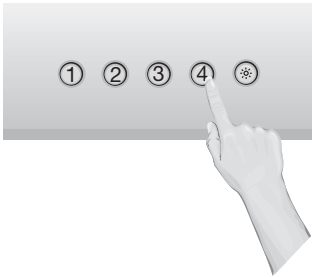

**Important Note:** Do not choose the highest fan speed right away. Press the buttons to increase the speeds one by one before entering the highest fan mode.

- 4 Press the same button to turn the fan off.

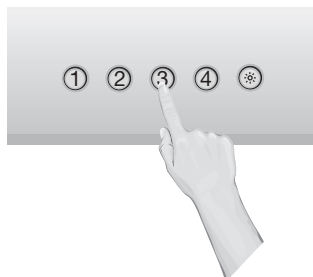

## Turning the Light On or Off

- 1 Press the ☀ button to turn the light on.

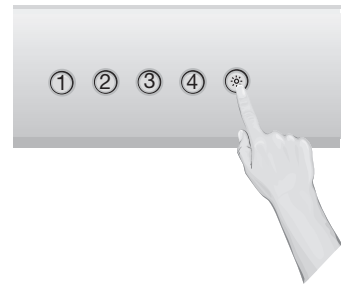

- 2 Press the ☀ button again to turn the light off.

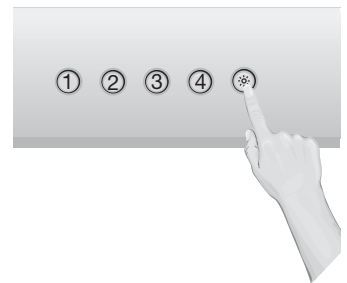



# Maintenance

## Replacing the Light Bulbs

**1** Unplug the unit from the AC outlet.

**2** Remove five screws from the light panel, then remove the light bulbs by popping them out.

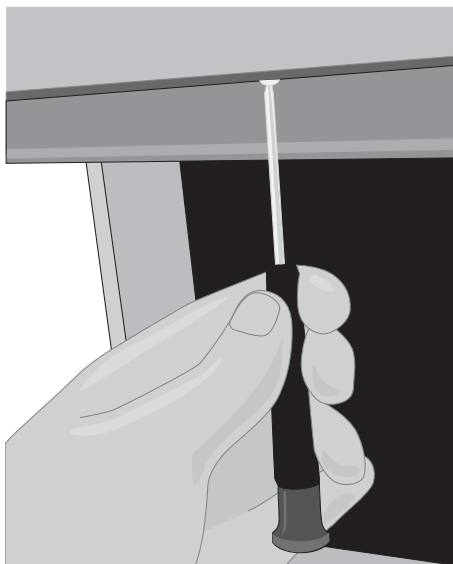

**3** Disconnect the light clip.

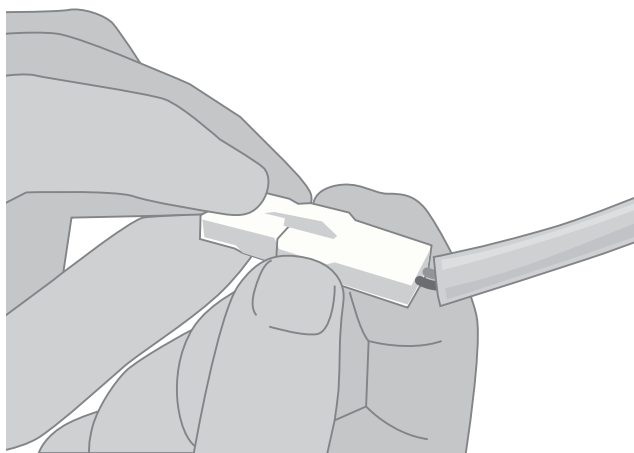

**4** Reverse the removal procedures to install the new light bulbs and plug the unit back in.

## Cleaning the Range Hood



Be sure electrical power is off and all surfaces are cool before cleaning or servicing any part of the hood.

### Range Hood Body

- Do not use a steel wool pad; it will scratch the surface.
- To clean the stainless steel surface, use warm soapy water or a stainless steel cleaner. Closely follow the cleanser label instructions. **DO NOT** use corrosive or abrasive detergents, ammonia products, abrasives or oven cleaners. Always wipe the surface in the direction of the grain.

### Baffle Filters and Grease Trays

- The saturation of greasy residue in the fan and filters may cause increased inflammability. Keep unit clean and free of grease and residue build-up at all times to prevent possible fires.
- Baffle filters and grease trays can be cleaned in a standard dishwasher or by using a mild cleaner. **DO NOT** use corrosive or abrasive detergents, ammonia products, or oven cleaners.
- To remove, first drain and wipe all excess grease with a dry paper towel. Grasp the baffle filter knobs and pull them up, forward and out. Grasp the grease trays and carefully lift them up and out of the hood track.

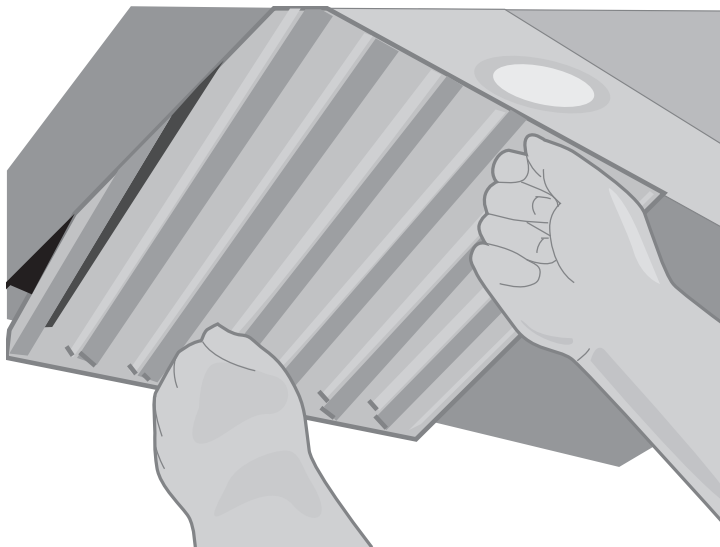

- When cleaning is completed, replace the grease trays and baffle filters as shown in Step 13 and Step 14.

# Replacement Parts

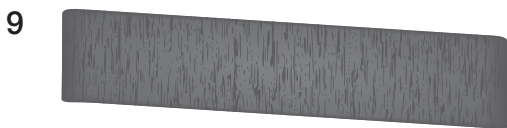
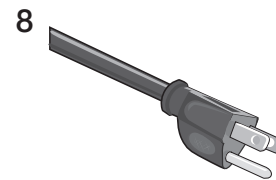
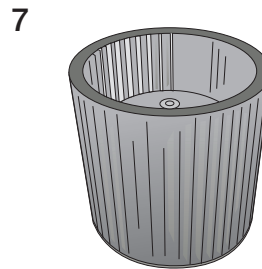
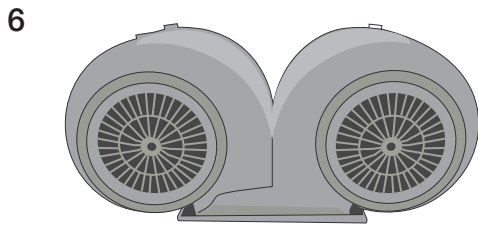
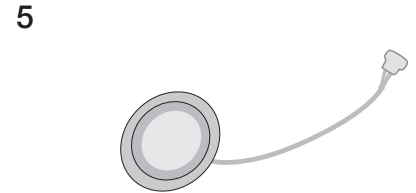
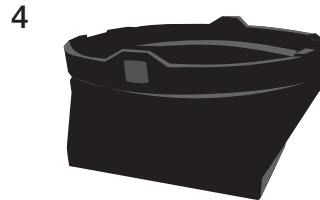
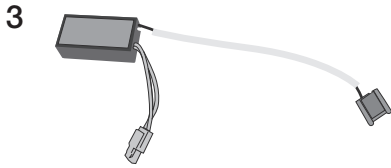
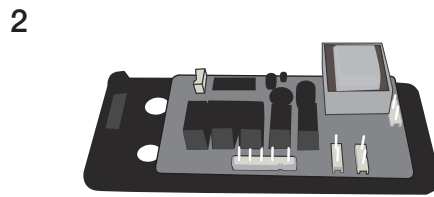
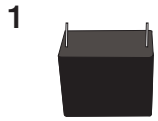

15A & 15B

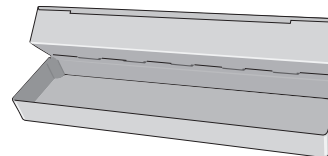

Description	Part Code
1 - Capacitor	PACAP-15
2 - Circuit Board	PABRD-14
3 - Transformer	PATRA-13
4 - Damper	PADAM-14
5 - Light Bulb	PRH-0225
6 - Motor	PAMOT-14
7 - Squirrel Cage	PAMCG-12
8 - Power Cord	PAPWR-12
9 - Wood Support	PABRK-08

Description	Part Code
10 - Light Panel 30***	PALPL-20
11 - Light Panel 36***	PALPL-21
12 - Hardware Bag*	PASCR-16
13 - Baffle Filter - 30***	PA02058
14 - Baffle Filter - 36***	PA02060
15A - Grease Tray - 30***	PAGTR-03
15B - Grease Tray - 36***	PAGTR-04

\*Not Shown.  
See page 6 for illustration of items 13 and 14.

Please register your product warranty by visiting the Ancona Home website.



Canada & USA

Phone: 1-800-350-4562

Fax: 800-350-8563

Email: [service@anconahome.com](mailto:service@anconahome.com)

Website: [www.anconahome.com](http://www.anconahome.com)

Ancona is in association with Mr Appliance for all after sales service calls.  
Please contact their service provider or visit their website:

Phone: 888-998-2011

Website: [www.mrappliance.com](http://www.mrappliance.com)



MAAN1244-03